

loopy . glider . take-off

m g r

design:
Perin & Topan

Un'ampia gamma di finiture e materiali caratterizza le linee manageriali di Loopy, Glider e Take-Off permettendo di arredare spazi direzionali e meeting contemporanei.

A wide range of finishes and materials characterize the managerial lines of Loopy, Glider and Take-Off allowing you to furnish executive and contemporary meeting spaces.

Une large gamme de finitions et de matériaux caractérise les lignes managériales de Loopy, Glider et Take-Off en vous permettant de meubler des espaces de réunion exécutifs et contemporains.

Eine große Auswahl an Oberflächen und Materialien charakterisieren die Managementlinien Loopy, Glider und Take-Off, mit denen Sie Executive- und moderne Besprechungsräume einrichten können.

Una amplia gama de acabados y materiales caracterizan las líneas gerenciales de Loopy, Glider y Take-Off que le permiten amueblar espacios de reunión ejecutivos y contemporáneos.













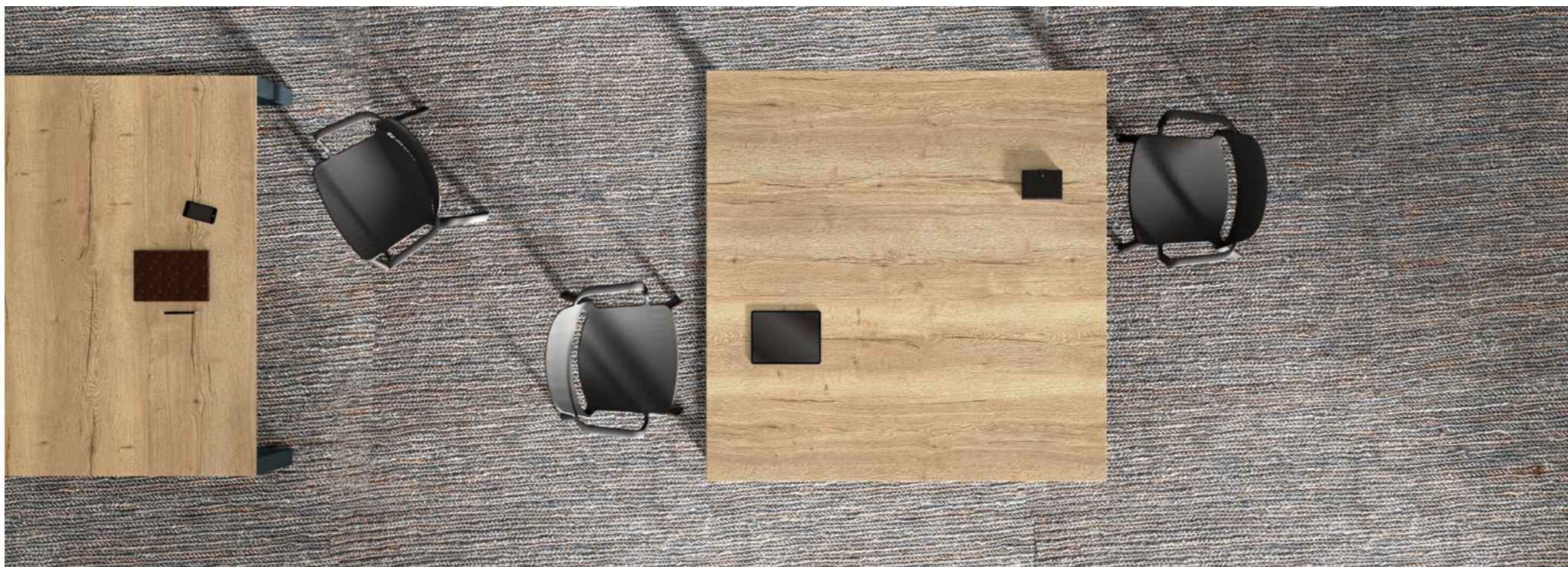

Vasta scelta di forme e dimensioni: dal tavolo riunione compatto ai sistemi modulari per sale di grandi dimensioni.

Wide choice of shapes and sizes: from the compact meeting table to modular systems for large rooms.

Large choix de formes et de tailles : de la table de réunion compacte aux systèmes modulaires pour les grandes salles.

Große Auswahl an Formen und Größen: vom kompakten Besprechungstisch bis zum modularen System für große Räume.

Amplia variedad de formas y tamaños: desde la mesa de reunión compacta hasta los sistemas modulares para salas grandes.







Tavolini bassi coordinati per arredare le zone lounge.

Coordinated low tables to furnish lounge areas.
Tables basses coordonnées pour meubler les espaces lounge.
Koordinierte niedrige Tische zur Einrichtung von Loungebereichen.
Mesas bajas coordinadas para amueblar zonas lounge.



legno, veneer, bois,
Holz Furnier, madera

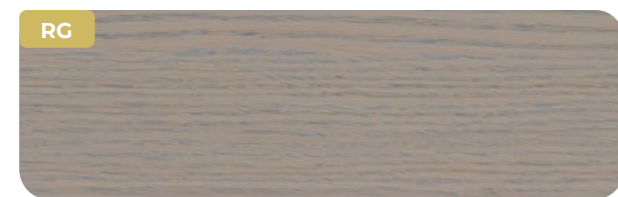
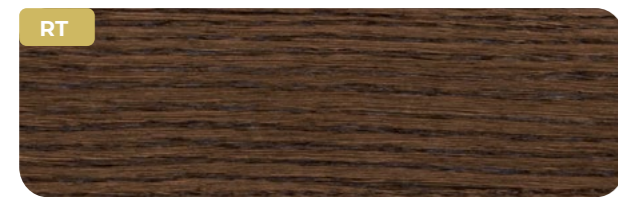
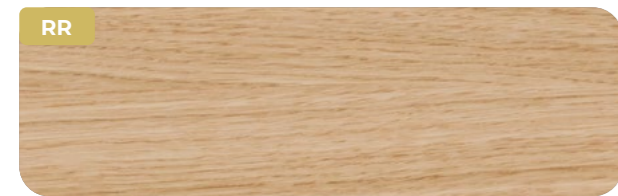

melaminico, melamine, mélamine,
melamin, melamina

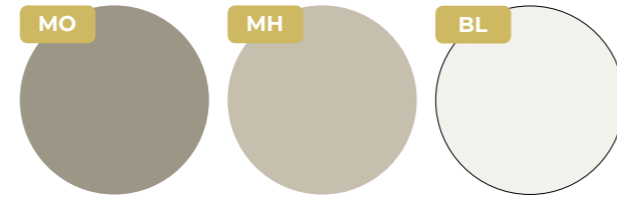

vetroceramica, ceramic glass, vitroceramique,
glaskeramik, vidrio cerámica

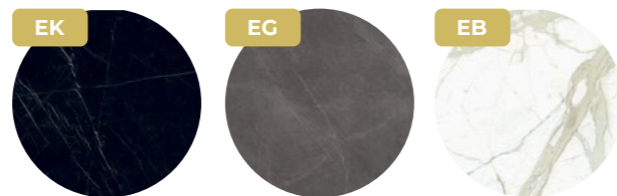

vetro temperato retrolaccato, back-lacquered tempered glass, verre retro-lacqué trempé,
sicherheitsglas rückseitig lackier, vidrio retrolacado templado



C_ (lucido · glossy · brillant · poliert · brillo)

S_ (opaco · matt · opaque · matt · mate)

vetro temperato, tempered glass, verre trempé,
sicherheitsglas, vidrio templado

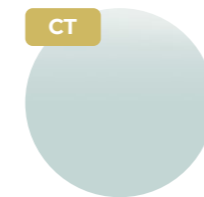

strutture metalliche, metal structures, structures métalliques,
metallgestelle, estructuras metálicas

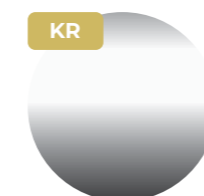
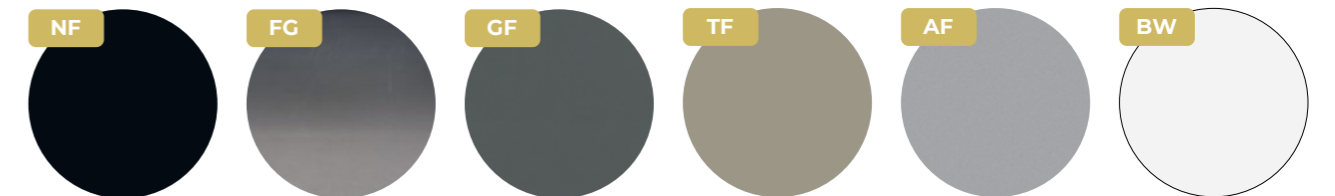

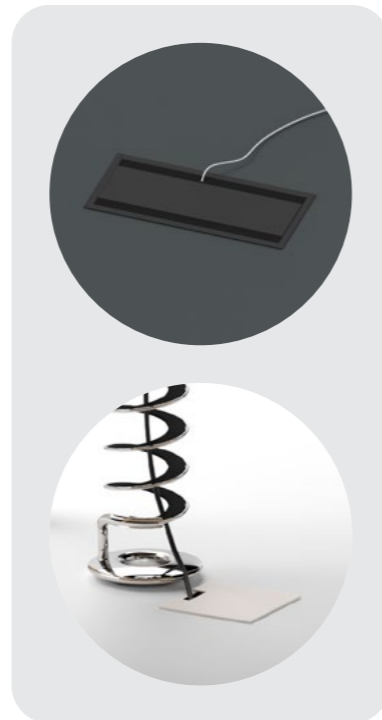
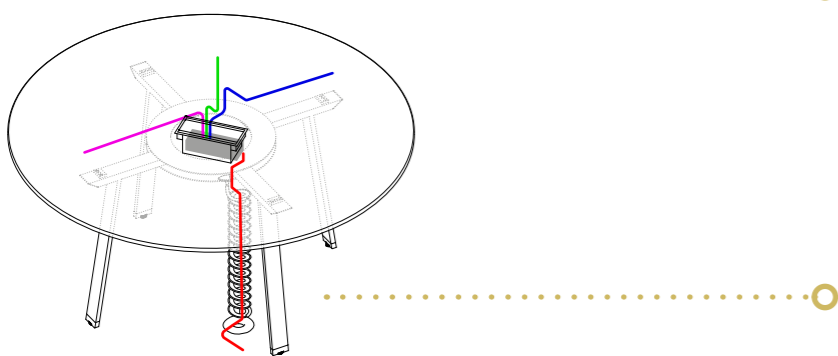
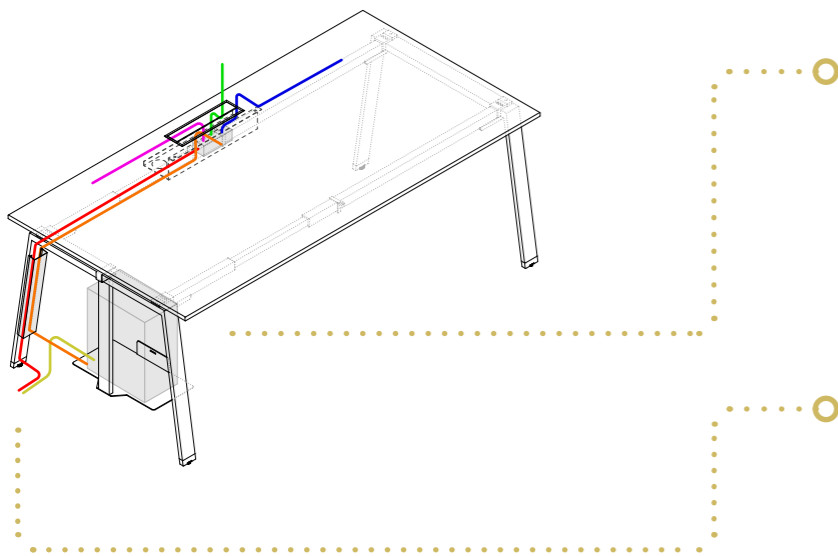

Loopy



Glider



Take-Off

S 1,2 cm: w 100÷120 cm d 60 cm
w 140÷200 cm d 80 cm
w 200 cm d 100 cm

h 74 cm

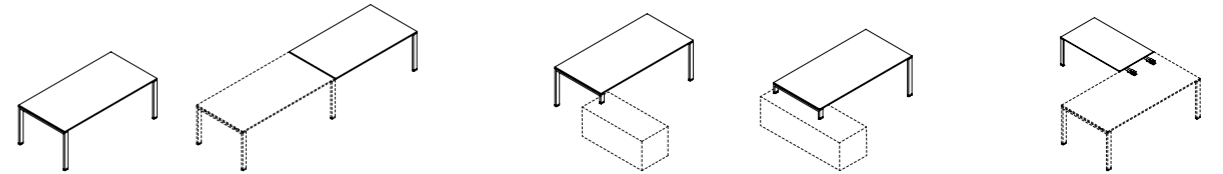

w 80÷200 cm
d 60-80 cm

w 200 cm
d 100 cm

w 160÷200 cm
d 80 cm

w 200 cm
d 100 cm

w 80-120 cm
d 60 cm

s 1,2-1,6-1,8-1,9 cm

h 2 cm

h 30 cm

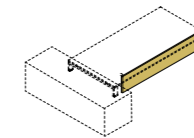
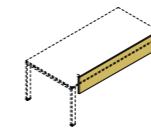
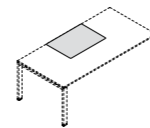

w 70 cm
d 50 cm

w 118,5-138,5-158,5 cm
d 1,8 cm

w 98,5-118,5-138,5 cm
d 1,8 cm

h 54 cm

h 54 cm

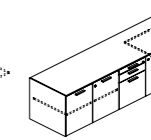
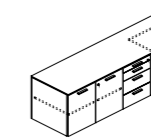
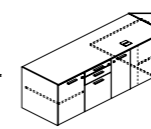
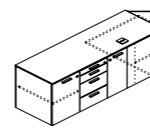

w 167,2 cm
d 56,2 cm

w 208,9 cm
d 56,2 cm

h 58,7 cm

h 54 cm

h 54 cm

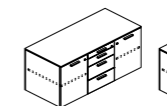
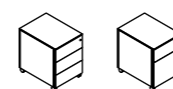

w 32-42 cm
d 56,2 cm

w 83,6 cm
d 56,2 cm

w 125,3 cm
d 56,2 cm



Loopy



Glider



Take-Off

h 73,7 cm

h 124,9 cm

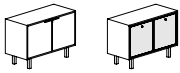

w 102,4 cm
d 46 cm

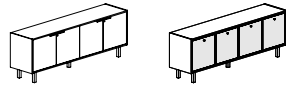

w 202,4 cm
d 46 cm

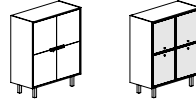

w 102,4 cm
d 46 cm

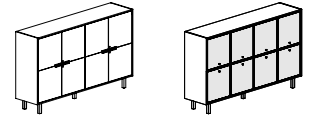

w 202,4 cm
d 46 cm

h 74 cm

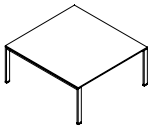

w 100÷240 cm
d 124-164 cm

s 1,8 cm

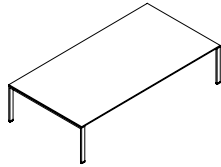

w 240 cm
d 124 cm

s 1,2 cm

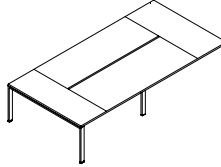

w 280-320 cm
d 124-164 cm

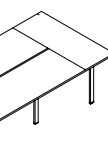

w 240-320 cm
d 124-164 cm

s 1,8 cm

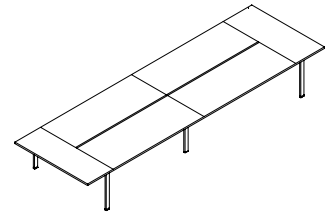

w 360-520 cm
d 124-164 cm



h 74 cm

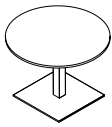

ø 110-118 cm

s 1,8 cm

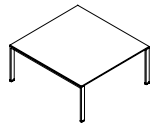

w 124 cm
d 124 cm

s 1,2 cm

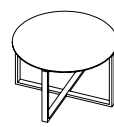

ø 118 cm

s 1,2-1,8 cm

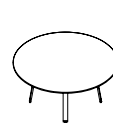

ø 118 cm

s 1,2-1,8 cm



h 38 cm

h 42 cm

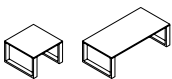

w 60-120 cm
d 60 cm

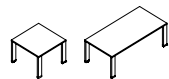

w 60-120 cm
d 60 cm