

po  
la  
re

**Un sistema modulare per vivere qualsiasi  
soluzione nell'ambiente di lavoro  
con l'atmosfera ed il calore di casa.**

A modular system to experience many  
solutions in collaborative offices  
with the atmosphere of home.

Un système modulaire pour vivre chaque  
solution de travail avec l'atmosphère et la  
chaleur de la maison.

Ein modulares System zum Erleben  
jeder Lösung in der Arbeitsumfeld mit  
die Atmosphäre und Wärme von zu Hause.

Un sistema modular para hacer cualquiera  
solucion en el ambiente de trabajo con  
atmosfera y calor del hogar.

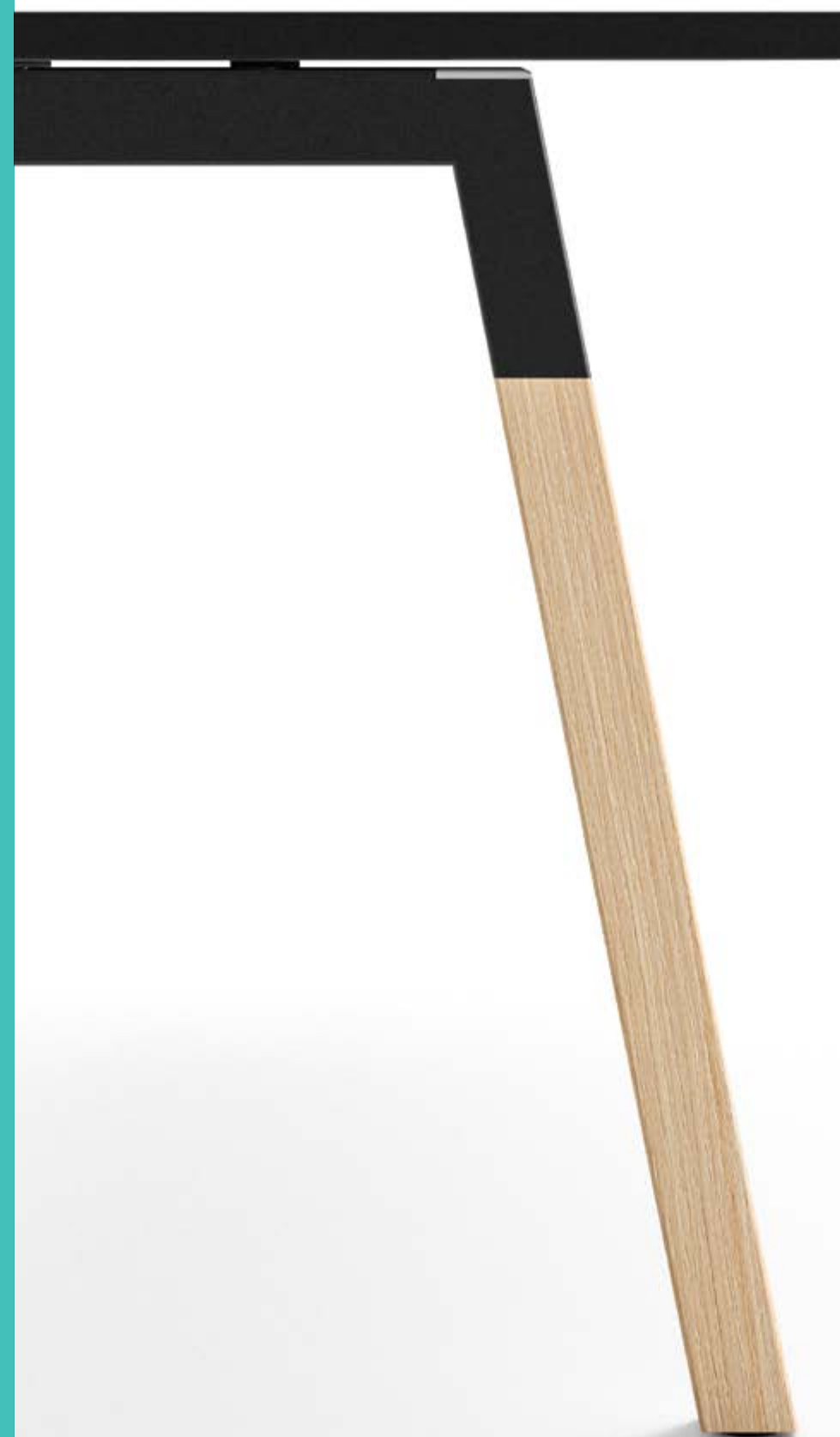









**Dai vita a un ambiente di lavoro accogliente e informale con i tavoli meeting e le panche dedicate Polare.**

Create a welcoming and informal work environment with Polare meeting tables and dedicated benches.

Créez un environnement de travail accueillant et informel avec les tables de réunion Polare et les banquettes dédiées.

Schaffen Sie ein einladendes und informelles Arbeitsumfeld mit Polare-Besprechungstischen und speziellen Bänken.

Cree un ambiente de trabajo acogedor e informal con mesas de reuniones Polare y bancos especiales.











**Elektrifizazione integrata, vasta gamma di contenitori ed accessori fanno di Polare un sistema funzionale e di design.**

Integrated electrification, a wide range of storage and accessories make Polare a functional and design system.

L'électrification intégrée, une large gamme de conteneurs et d'accessoires font de Polare un système fonctionnel et design.

Eingebaut Elektrifizierung, eine breite Palette an Behältern und Zubehör machen Polare zu einem Funktions- und Designsystem.

La electrificación integrada, una amplia gama de contenedores y accesorios hacen de Polare un sistema funcional y de diseño.









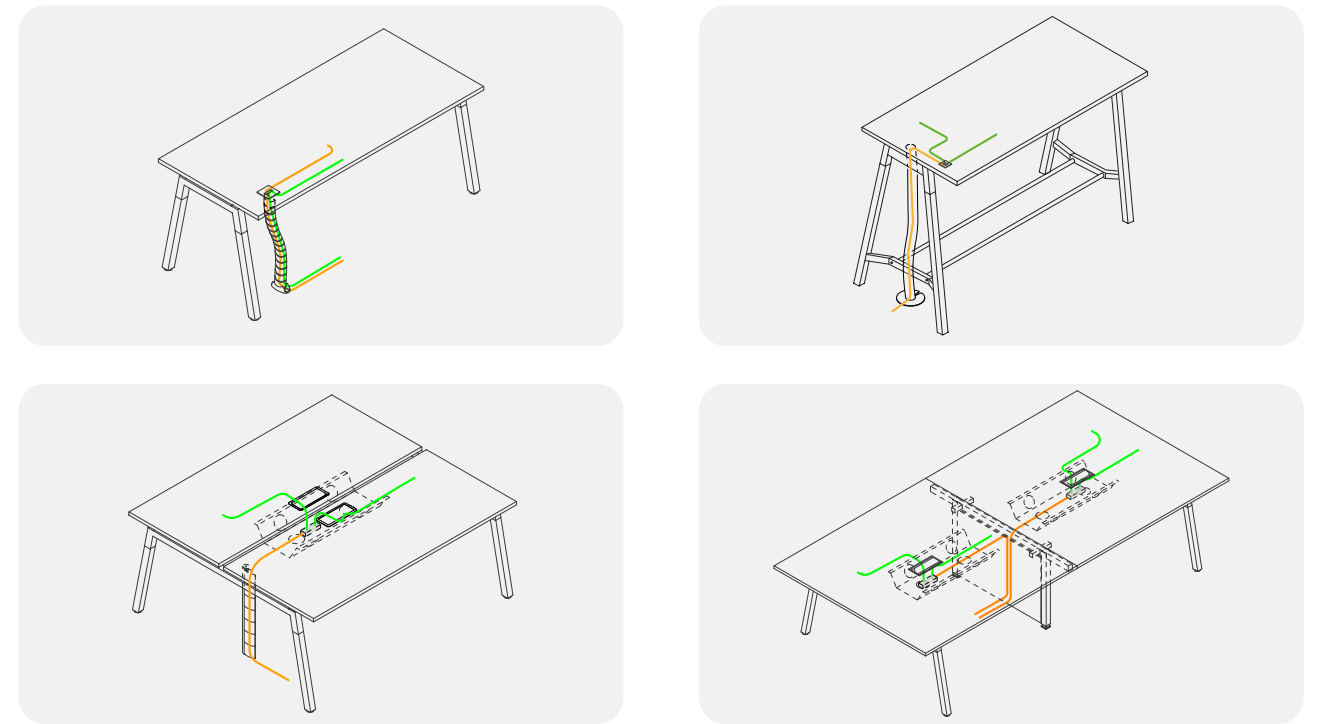
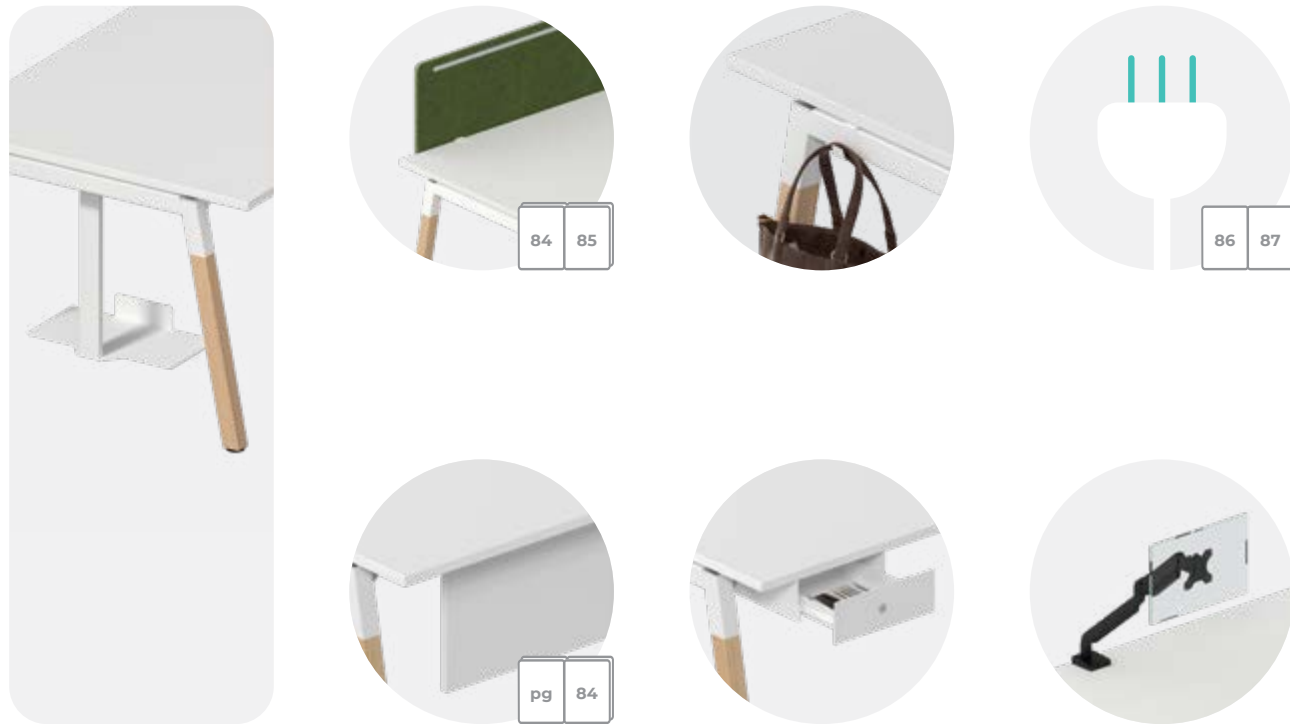

finiture • finishes • finitions • Ausführungen • acabados

**numero finiture**, number of finishes, numéro de finitions, Anzahl der Ausführungen, numero de acabados



3

**melaminico**, melamine, mélamine, melamin, melamina



2

**metallo**, metal, métal, Metall, metal

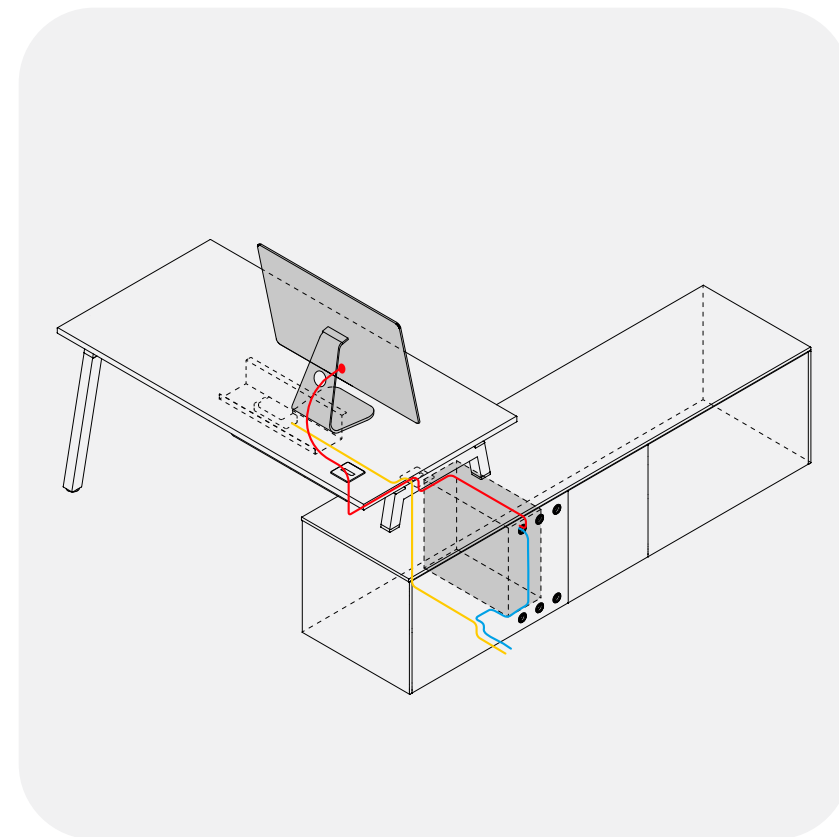

H: 74 cm

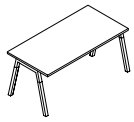

w 80÷200 cm  
d 60 - 80 cm

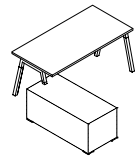

w 140÷200 cm  
d 80 cm

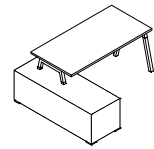

w 140÷200 cm  
d 80 cm

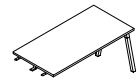

w 60÷200 cm  
d 60 cm

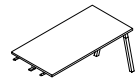

w 80÷200 cm  
d 80 cm

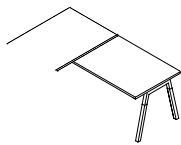

w 60÷120 cm  
d 60 cm

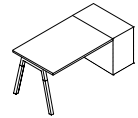

w 120÷200 cm  
d 60 - 80 cm

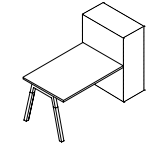

w 120÷200 cm  
d 80 cm

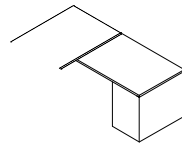

w 80 - 120 cm  
d 60 cm

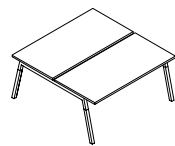

w 140÷200 cm  
d 124 - 164 cm

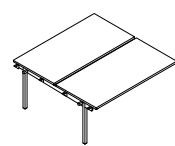

w 140÷200 cm  
d 124 - 164 cm

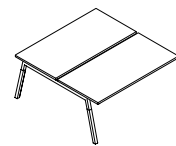

w 140÷200 cm  
d 124 - 164 cm

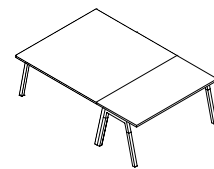

w 124 cm 164 cm  
d 60 cm 80 cm

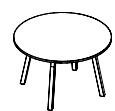

∅ 120 - 140 cm

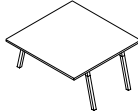

w d 164 cm

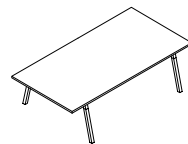

w 240 cm  
d 124 cm

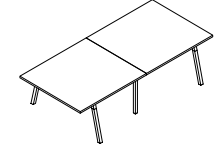

w 248 cm  
d 124 cm

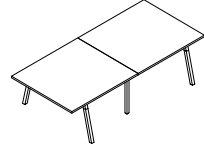

w 328 cm  
d 164 cm

H: 44 cm

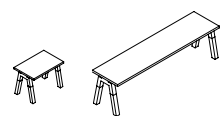

w 80 - 160 cm  
d 40 cm



∅ 120 - 140 cm



w 140÷200 cm  
d 80 cm

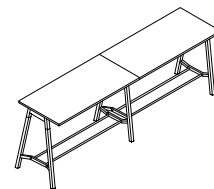

w 280÷400 cm  
d 80 cm

H: 105 cm

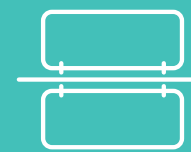

83 - 85

**schermi e gonne** ·

screens and modesty panels · écrans et voiles de fond ·  
Sichtschutzpaneele und Knieraumblende · pantallas y faldones



86 - 87

**accessori per elettrificazione** ·

accessories for electrification · accessoires pour électrification ·  
Zubehör für Elektrifizierung · accesorios para electrificación



**tipologie di schermi** • types of screens • types d'ecrans •  
Typ der Sichtschutzpaneelen • tipos de pantallas

**schermi scrivania**, desk screens, écrans pour bureau, Sichtschutzpaneelen für Schreibtisch, pantalla escritorio

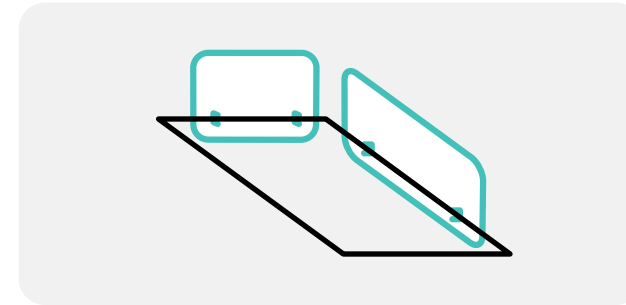
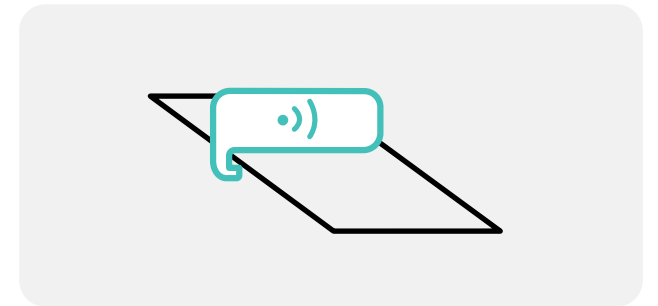
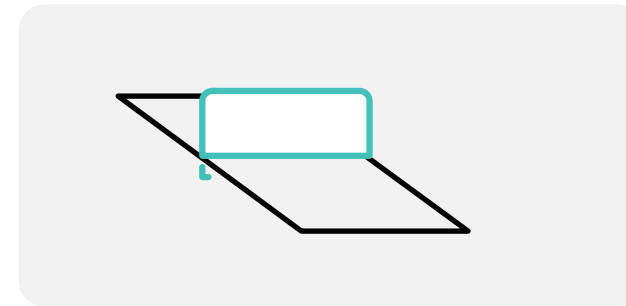

**schermi bench**, bench screens, écrans pour bench, Sichtschutzpaneelen für Bench, pantallas bench

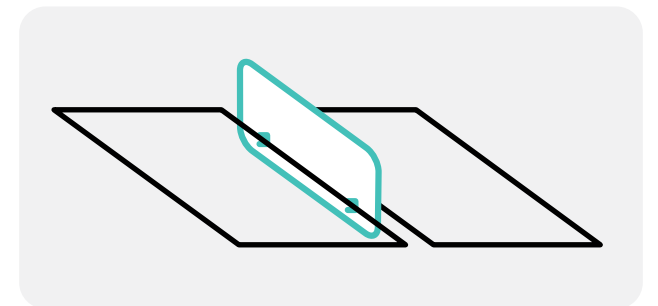
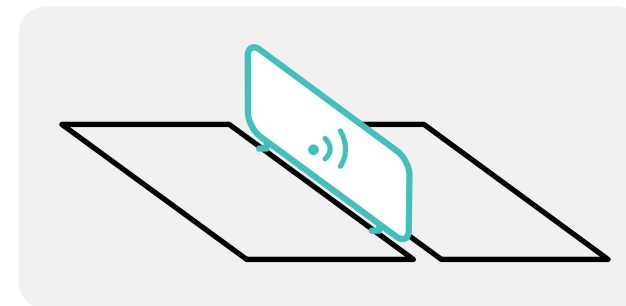
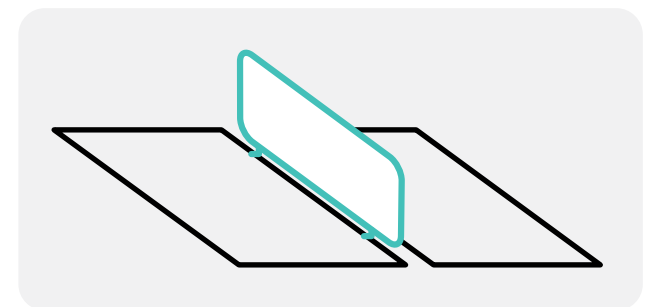
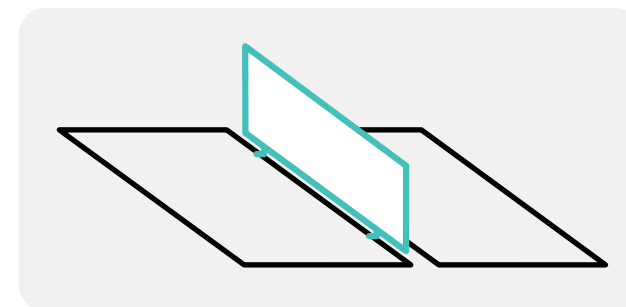

**schermi scrivania** • desk screens • écrans pour bureau • Sichtschutzpaneelen für Schreibtisch • pantalla escritorio

h: 38 cm

**schermo scrivania con aggancio piano**, desk screen with top fixing, écran pour bureau avec fixation au plateau, Sichtschutzpaneelen für Schreibtisch mit Tischplatte befestigung, pantalla escritorio con enganche sobre



h: 48 cm h': 38 cm

**schermo scrivania sagomato fonoassorbente**, shaped soundproof desk screen, écran acoustique pour bureau, Abgerundete Schallschluckend Sichtschutzpaneelen, pantalla escritorio perfilado fonoabsorbente



**schermo scrivania**, desk screen, écran pour bureau, Schirm für Schreibtisch, pantalla mesa



**schermo scrivania laterale**, lateral screen for desk, écran latéral pour bureau, Seitliche Schirm, pantalla lateral



**vaschette opzionali per profili**, optional trays for profiles, bacs optionnels pour profils, optionale Utensilieschale für Profile, bandejas opcionales para perfiles



**staffe**, brackets, étriers, Bügel, estribos



**metallo**, metal, métal, metall, metal



**finiture** • finishes • finitions • Ausführungen • acabados

**tessuto**, fabric, tissu, stoff, tejido



**schermi bench** • bench screens • écrans pour bench • Sichtschutzpaneelen für Bench • pantallas bench

h: 48 cm h': 38 cm

**schermo bench con aggancio piano**, bench screen with top fixing, écran pour bench avec fixation au plateau, Sichtschutzpaneelen für Bench mit Tischplatte befestigung, pantalla bench con enganche sobre



h: 38 cm

**schermo bench a 90°**, 90° corners' bench screen, écran bench à 90°, Sichtschutzpaneelen für Bench bei 90°, pantalla bench a 90°



**schermo bench**, workstation screen, écran pour bench, Schirm für Doppeltisch, pantalla bench



h: 57,5 cm

**schermo per bench Winglet e/push**, screen for Winglet e/push workstation, écran pour bench Winglet e/push, Sichtschutzpaneelen für Winglet e/ Push-knopf Bench, pantalla bench Winglet y push



h: 86,5 cm



**gonna pannello** • modesty panel • voile de fond Knieraumblende • tablero frontal

h: 30 cm



**melaminico**, melamine, mélamine, melamin, melamina

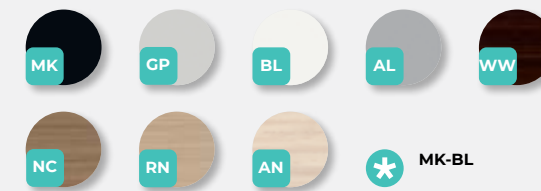

**laccato opaco**, lacquered matt, lacqué mat, matt lackiert, lacado mate



**vetro**, glass, verre, Glas, vidrio





**passacavi in lamiera**, metal cable tray, bac passe-câbles, Stalblech Kabelwanne, cestos portaenchufes



w: 50 - 120 cm



**cestelli portacavi ruotabile ed ispezionabile**, wire cable tray, goulottes passe-câbles basculantes, Abklappbare Kabelwanne, cestos portaenchufes que se giran e inspeccionables

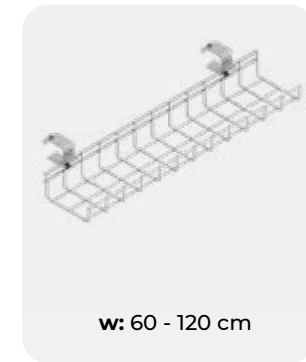

w: 60 - 120 cm



**passacavi in lamiera per bench**, bench metal cable tray, passe-câbles en tôle pour bench, Stalblech Kabelwanne für Bench, pasacables metálico para bench



w: 80 - 120 cm



**vasca passacavi**, metal cable tray, goulotte passe-câbles, Kabelwanne, cestos portaenchufes



w: 78 cm



**vasca passacavi telescopica bench**, telescopic cable tray for workstation, goulotte télescopique pour bench, Teleskop-Kabelwanne für Bench, cestos portaenchufes telescopico para bench



w: 90 cm



**passacavi verticale in plastica**, vertical plastic cable duct, vertèbre passe-câbles en plastique, Vertikale Kabelführung aus Plastik, pasacables vertical pvc

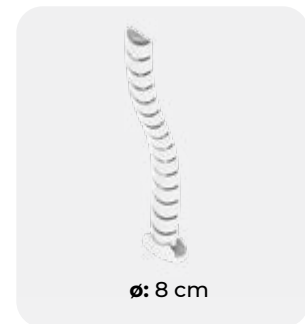

ø: 8 cm



**passacavi in tessuto**, vertical fabric cable duct, montée de câbles en tissu, vertikale Kabelführung aus Stoff, pasacables vertical en tejido

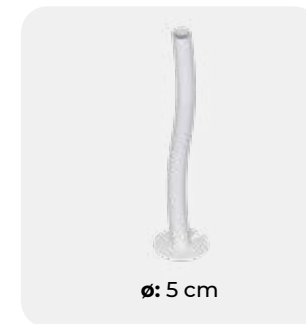

h: 75 - 135 cm



**passacavi verticale in lamiera**, vertical metal cable duct, passe-câbles, Kabelführung, pasacables



w: 3,5 cm



**coppia passacavi a spirale**, pair of spiral cables carrier duct, paire de montée de câbles à spirale, paar Spiral-Kabelführungen, par de espiral pasacables

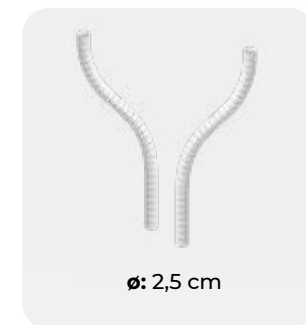

ø: 2,5 cm



**passacavi verticale**, vertical cable duct, vertèbre passe-câbles, Vertikale Kabelführung, pasacables vertical



w: 6 cm  
d: 4 cm



**tappo passacavi quadrato**, square cable access port, bouchon passe-cable carré, Quadratische Kabeldurchlass, tapon pasacables cuadrado



ø: 8 cm

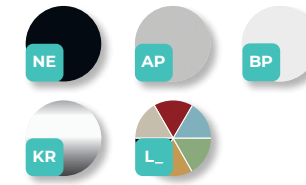

**tappo passacavi rotondo**, round cable access port, bouchon passe-cable rond, Runde Kabeldurchlass, tapon pasacables redondo



ø: 8 cm



**caricabatterie wireless 220v**, wireless charger 220v, chargeur de batteries sans fil 220v, 220v Wlan-batterieladegerät, cargador de batería wireless 220v



ø: 8 cm



**blocco portaprese versapad**, foldway socket holder versapad, boîtes de prises versapad, Steckdosenblock versapad, base de conexiones Versapad



ø: 8 cm



**top access**, top access, top accès Tischklappe, acceso superior



w: 26 cm



**top access con doppia apertura**, top access with dual opening system, top accès avec double ouverture, Beidseitig aufklappbar tischklappe, acceso superior con sistema de doble apertura



w: 26,2 cm



**top access**, top access, top accès Tischklappe, acceso superior



w: 35 cm



**top access**, top access, top accès Tischklappe, acceso superior



w: 25 cm



**top access**, top access, top accès Tischklappe, acceso superior



w: 10,7 cm



**caricabatterie usb versapick**, usb charger versapick, chargeur de batteries usb versapick, Usb-batterieladegerät versapick, cargador USB Versapick



ø: 3,5 cm



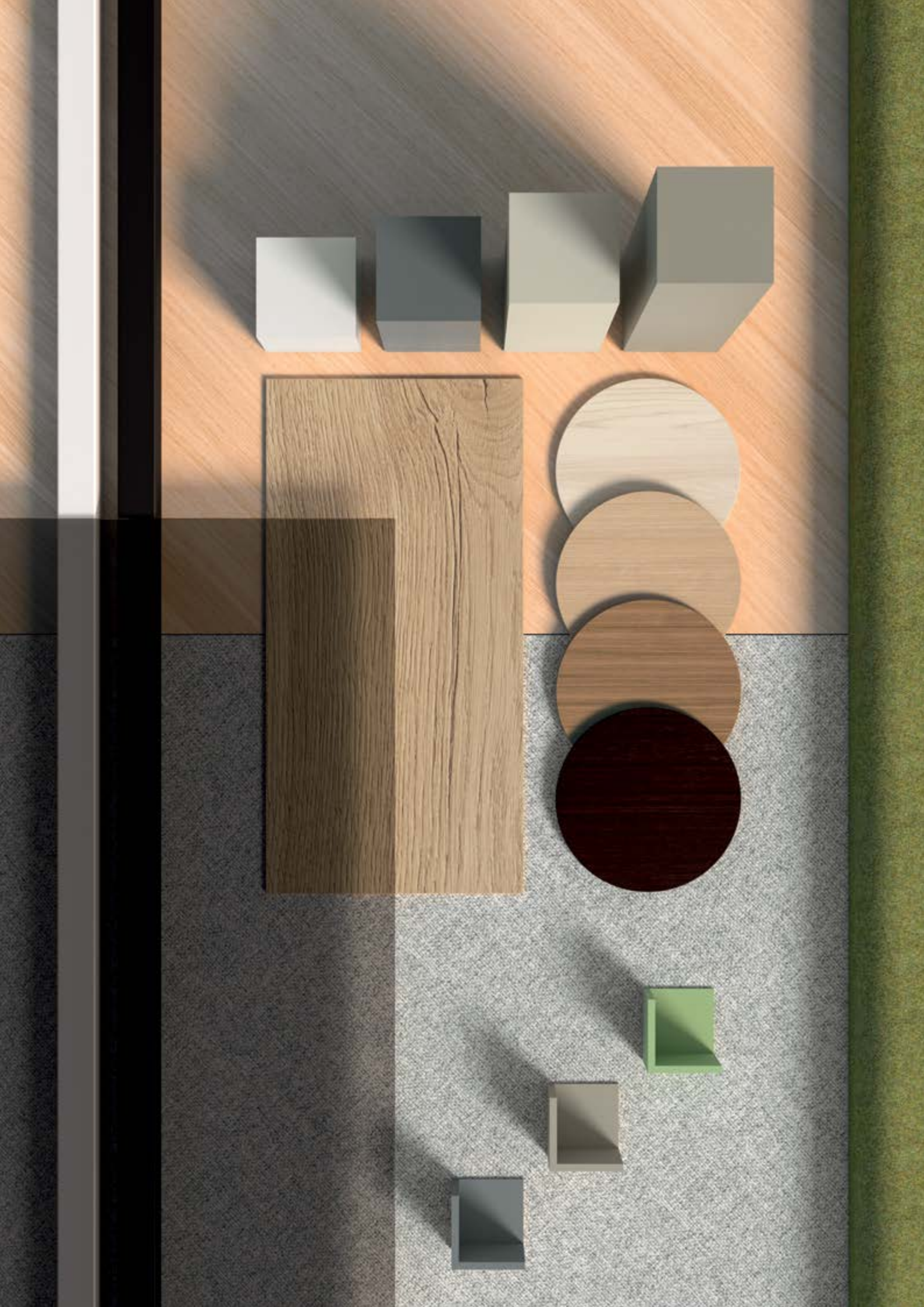



**melaminico** • melamine • mélamine • melamin • melamina



**nero**, black, noir, schwarz, negro

**grigio perla**, pearl-grey, gris perle, perlgrau, gris perla

**bianco**, white, blanc, weiß, blanco

**wengé scuro**, dark wengé, wengé foncé, dunkel Wengé, wengé oscuro

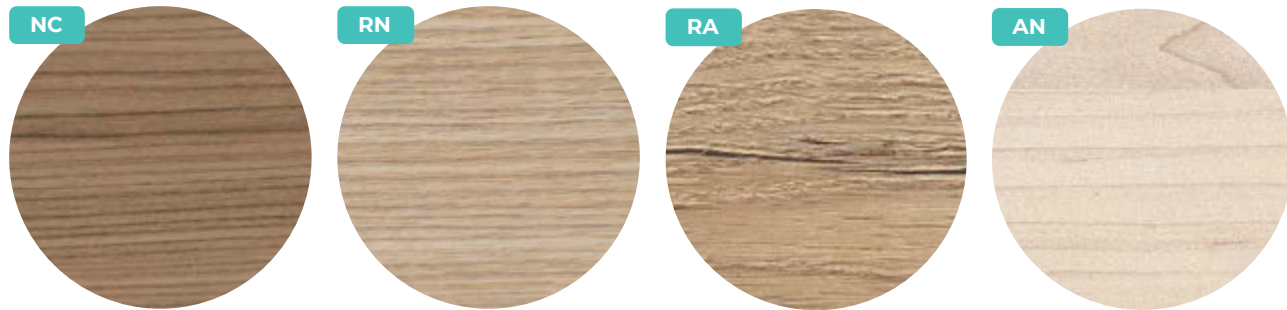

**noce canaletto**, canaletto walnut, noyer canaletto, Canaletto Nussbaum, nogal canaletto

**rovere naturale**, natural oak, chêne naturel, Natur Eiche, roble natural

**rovere anticato**, traditional oak, chêne vieilli, Eiche Antik, roble antiguo

**acero champagne**, champagne hard maple, érable champagne, champagner-ahorn, arce champán



**RA - AN Superficie antibatterica**, antibacterial surface, surface antibactérienne, Antibakterielle Oberfläche, superficie antibacteriana

**legno** • veneer • bois • holz • madera



**rovere naturale**, natural oak, chêne naturel, Natur Eiche, roble natural

**plastica** • plastic • plastique • Plastik • plástico

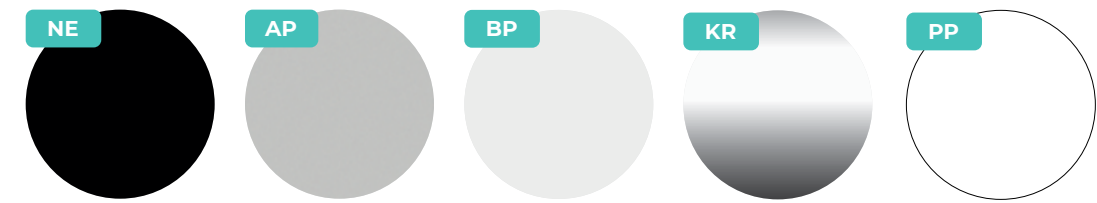

**nero**  
black  
noir  
schwarz  
negro

**alluminio**  
aluminium  
aluminium  
aluminium  
aluminio

**bianco**  
white  
blanc  
weiß  
blanco

**cromo lucido**  
glossy chrome  
chromé brillant  
Chrom poliert  
cromo brillo

**trasparente**  
transparent  
transparent  
klarsicht  
transparente

**metallo** • metal • métal • metall • metal



**nero**  
black  
noir  
schwarz  
negro

**epox alluminio**  
silver epoxy  
epoxy aluminium  
Epoxidharz aluminium  
epoxidico aluminio

**bianco**  
white  
blanc  
weiß  
blanco

**cromo lucido**  
glossy chrome  
chromé brillant  
Chrom poliert  
cromo brillo

**vetro temperato** • tempered glass • verre trempé • sicherheitsglas • vidrio templado

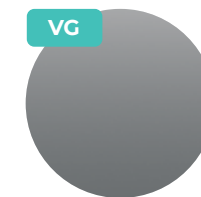

**fumé**  
transparent smoke grey  
gris fumé  
Rauchglas  
gris ahumado

**laccato opaco** • lacquered matt • lacqué mat •  
matt lackiert • lacado mate

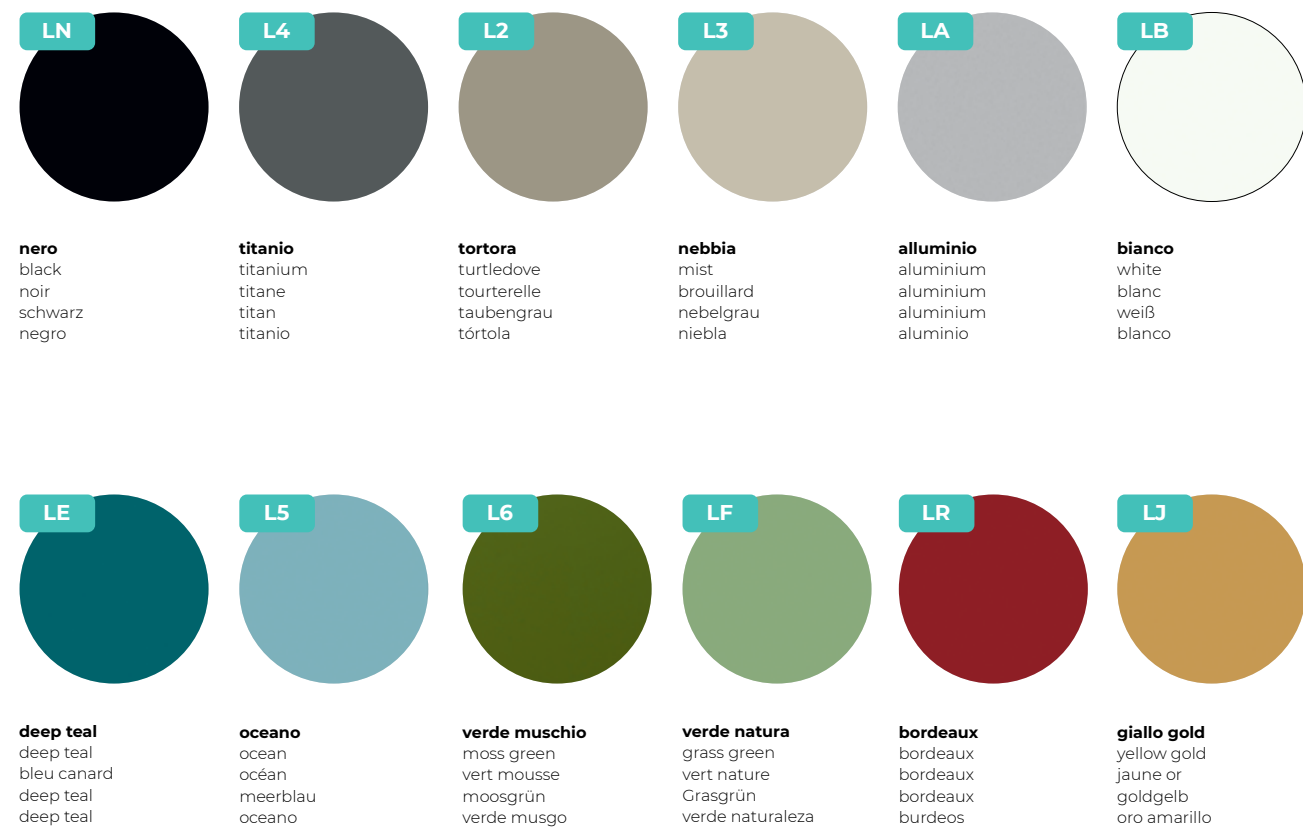

**tessuto** • fabric • tissu • stoff • tejido

**MIRAGE**

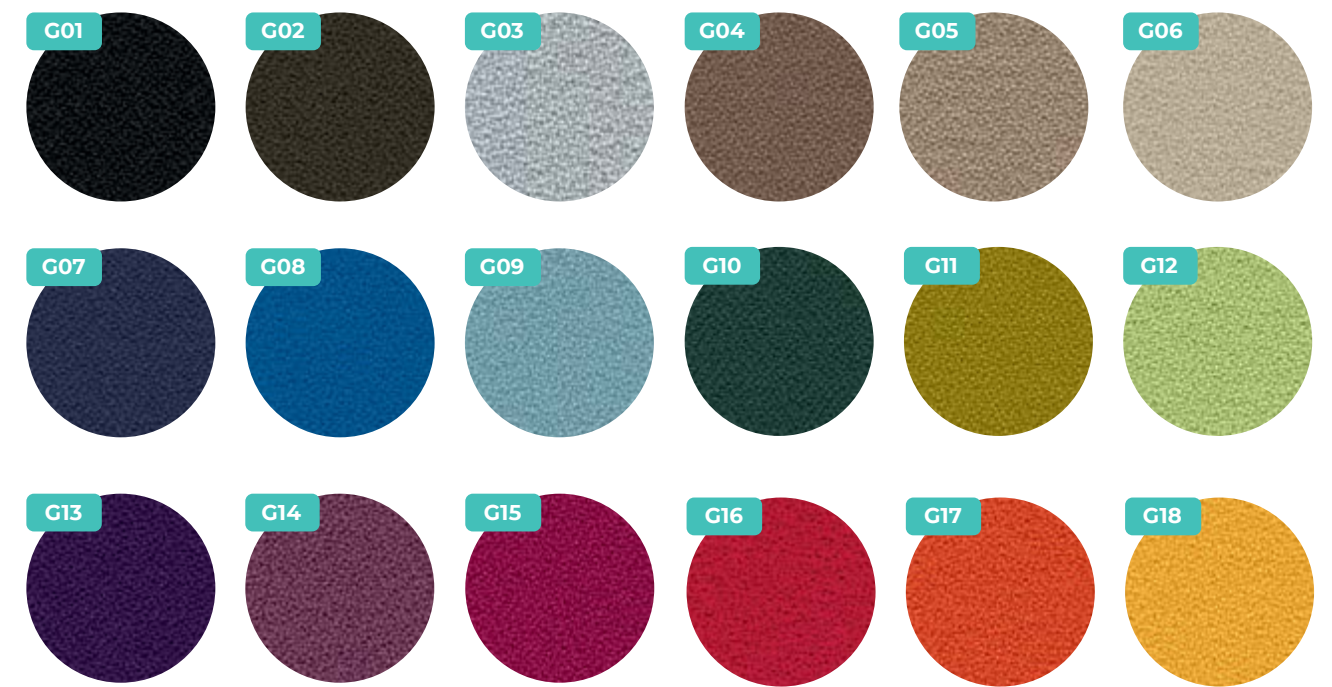

**NEMI MELANGE**



**FENICE**

