

# BUSYPOD

Design Of Silence





BUSYPOD

## BUSYPOD PRODUCTS

Are insulated study and meeting cabins consisting of Phone Booth, Medium Meet, Medium Work, Large and XLarge models. All BUSYPOD products consist of layers with sound insulation and acoustic properties, and different options are available according to the concept of your office. Their installation is quite simple. Phone Booth is designed to be installed in 15 minutes, Medium and Large in 30 minutes, and our largest product, XLarge, in 60 minutes. BUSYPODs are illuminated by LED lights and have a ventilation system. BUSYPOD frames can be made of natural wood and lacquered in the desired colour, and sound-controlled laminated glass is used in the windows. Acoustic carpet is used on the floor. In addition to these standard features, we also offer many features.

BUSYPOD products promise to get rid of the complex environment you are in and to offer you a calm environment. As soon as you enter, all communication from inside to outside and from outside to inside is cut off. All that's left is you, the jobs and meetings waiting for you.



BUSYPOD Medium Work



BUSYPOD Medium Meet



BUSYPOD Large



BUSYPOD XLarge



Non-flammable  
Material



Acoustic Laminated  
Glasses



Recycled Material



BUSYLOUNGE (4)



BUSYLOUNGE (2)

## BUSYLOUNGE PRODUCTS

Are for 2 and 4 people and are the meeting point and provide you privacy with acoustic and sound absorbing features. There are different options available according to your office concept. They are designed to be installed by 2 people in 20 minutes in BUSYLOUNGE(2) and in 20 minutes by 3 people in BUSYLOUNGE(4). BUSYLOUNGE's lighting is made by LED lights, its seats will take you out of the office environment and make you feel comfortable in your home. We are sure that you will have a very productive time with your teammates.



A quiet space designed for privacy and focus.

Get your oasis for the modern office. Dial-in, tune out, rehearse, review, create, debate – you name it – the minimalist BUSYPOD Phone Booth's potential for your open plan office is huge. No need to fight over the conference room or over-booked meeting rooms that were built for many people. No need to stand out in the corridor or stairwell to make that phone call. Our Phone Booths are soundproofed, comfortable spaces that come with a built-in desk as standard. Set up your laptop, put down your cup of coffee, layout some documents. The BUSYPOD Phone Booth is the solution you need to regain lost privacy in your open-plan office!



Busy Light



Power Module



Ergonomic Table

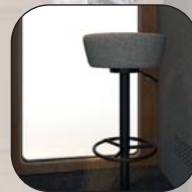

Adjustable Stool



Coat Hanger



Stainless Footstep



Acoustic Felt Panel



Air Ventilation

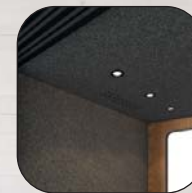

LED Lighting

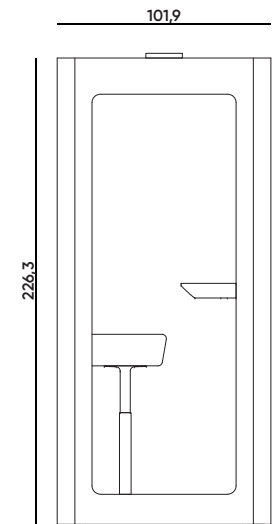
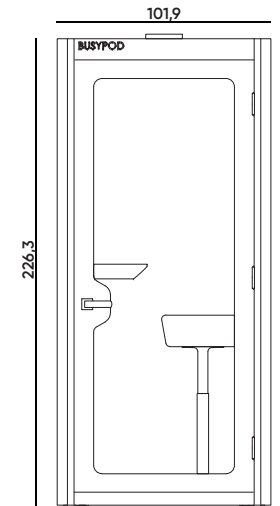
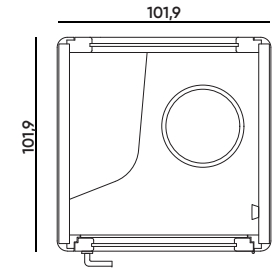

## BUSYPOD

Get into any BUSYPOD, concentrate and let your creativity show up. Have you ever desired there were fewer distractions in your office? Our phone booths help you eliminate sound both from outside and inside.

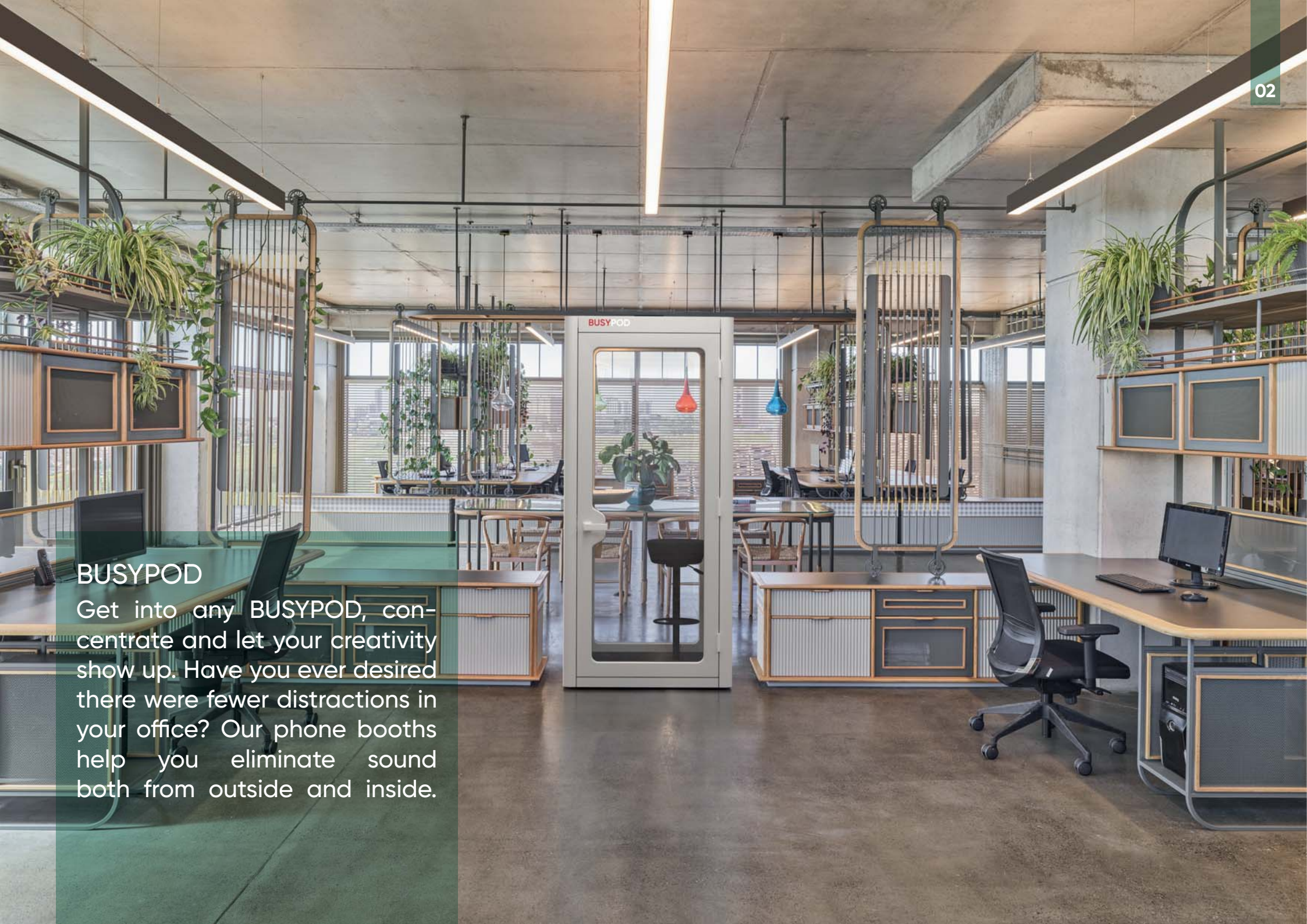

Take your work environment to the next level

Many people in large companies are very uncomfortable with occupying a whole room. BUSYPOD Medium Work occupies approximately 2 m<sup>2</sup> in an office environment and has a structure that will make you look like a huge meeting room. When you go inside and start working, all the sounds coming from outside will be cut off and you will be alone with your work and yourself. You can turn on the music you want and focus on your work, or you will have your video conferences in a comfortable environment where no one is watching you and your voice is not heard.



Busy Light



Power Module



Ergonomic Table



Air Ventilation

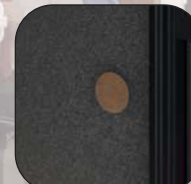

Coat Hanger



Stainless Footstep



Acoustic Felt Panel

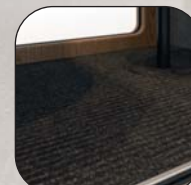

Carpet



LED Lighting

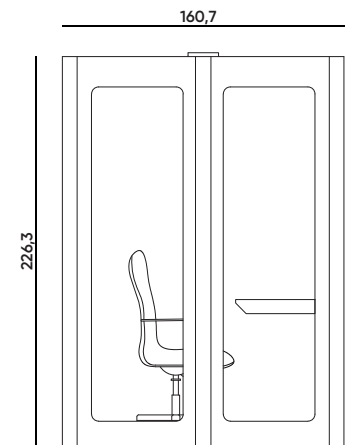
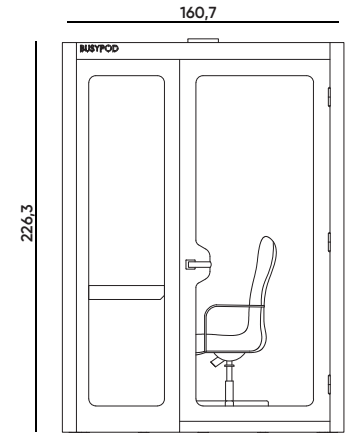
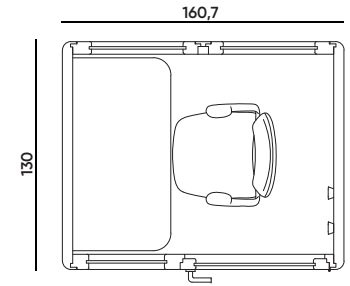



**BUSYPOD Medium Work**  
BUSYPOD Medium helps you focus on your work and at the same time, with its unique design, it adapts to every place located.

Sometimes life is just for two

There are never enough meeting spaces. Most meeting rooms are built for larger groups when the fact is, most meetings have just a few people. To build more meeting rooms can cost or just can not be right i practical. The pod comes with a large 2 person meeting table. Add two built-in, height adjustable stools, or provide your own. Perfect for a quick catchup with a colleague or visitor. Work on a report with a team member, dial-in a colleague working remotely, or just use the pod to read a legal document. The BUSYPOD Medium Meet is a cost-effective and easy way to add flexible meeting spaces to any office.



Busy Light



Power Module



Ergonomic Table



Adjustable Stool



Coat Hanger



Stainless Footstep



Acoustic Felt Panel



Air Ventilation



LED Lighting

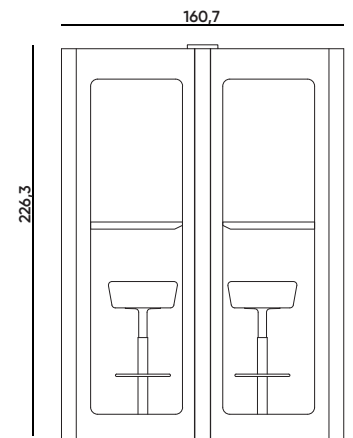
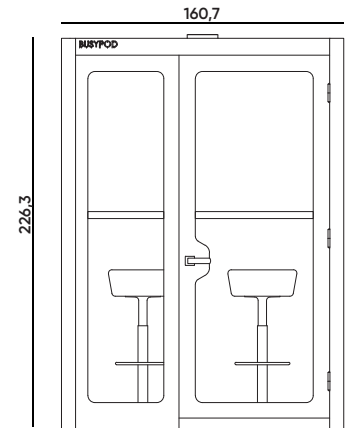
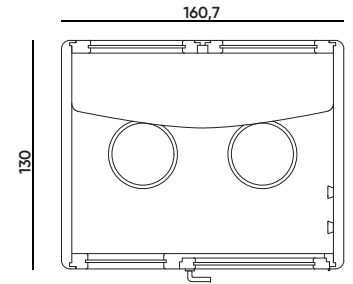

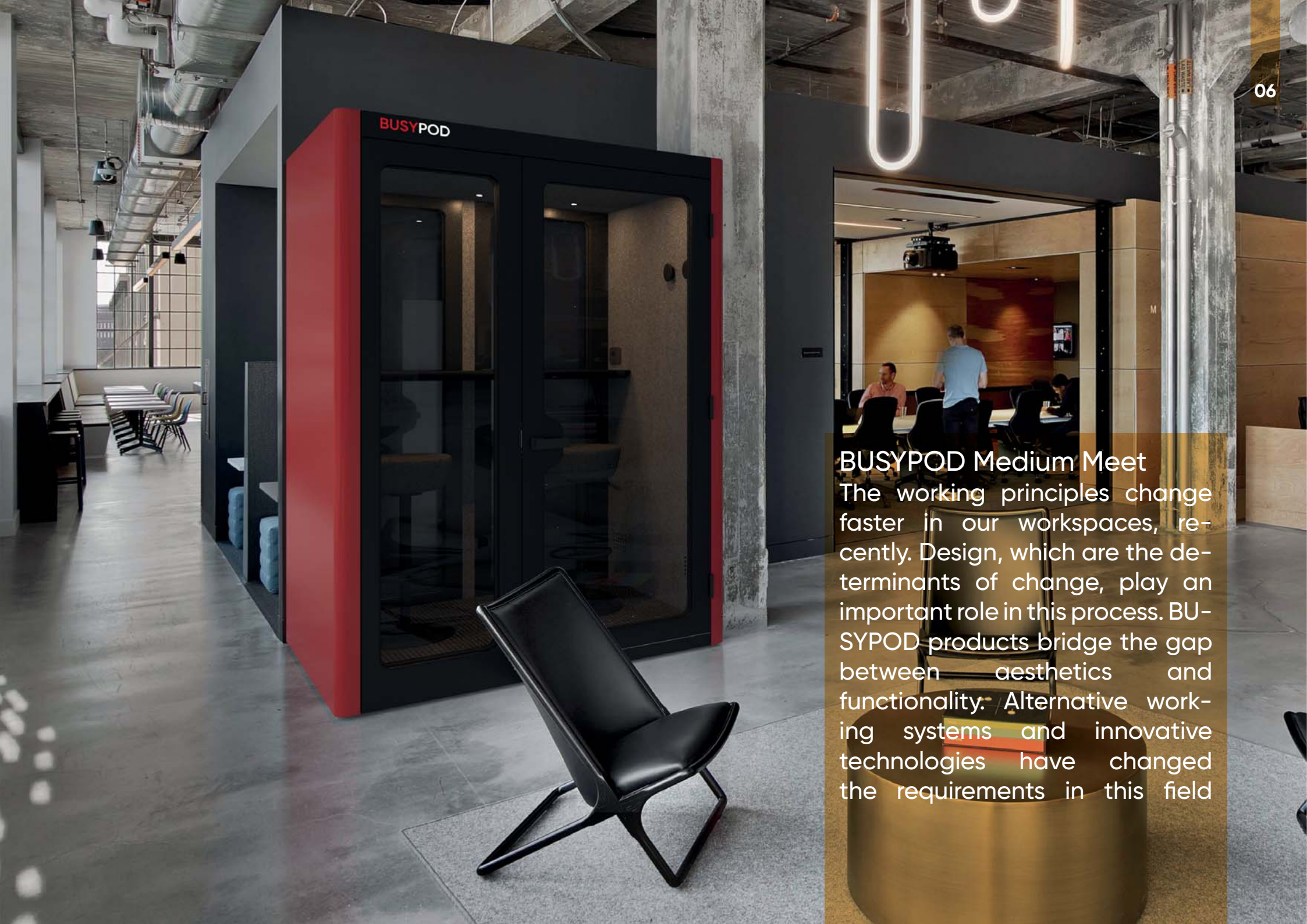

**BUSYPOD Medium Meet**  
The working principles change faster in our workspaces, recently. Design, which are the determinants of change, play an important role in this process. BUSYPOD products bridge the gap between aesthetics and functionality. Alternative working systems and innovative technologies have changed the requirements in this field



Where people and privacy meet.

Did you know over 70% of meetings have 4 people or less in them? Most offices don't have enough meeting spaces. The cost of building more meeting rooms can be prohibitive, or just damn right impractical. Maybe your lease is due to expire in 18 months anyway. So why build when you can quickly install a 4 person meeting pod which you can take with you when you move premises. Wall mount a screen for built-in video conferencing, meet with up to 3 of your colleagues, or just use the pod to get away and focus on that report you're working on. The BUSYPOD Large 4 person meeting room is a cost effective and easy way to add flexible meeting spaces to any office, when and where you need them.



Busy Light



Power Module



Ergonomic Table



Comfortable Sofa



Coat Hanger



Stainless Footstep



Acoustic Felt Panel



Air Ventilation



LED Lighting

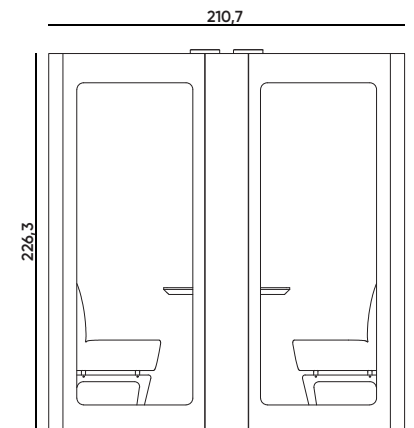
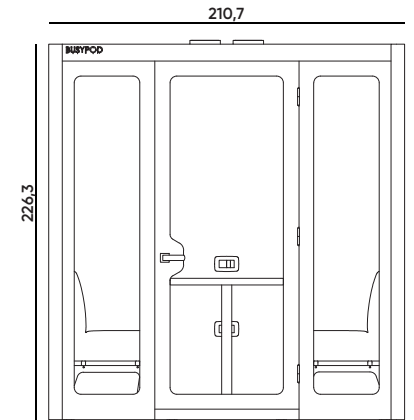
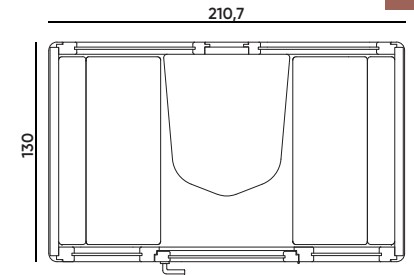

### BUSYPOD Large

One of the most important benefits of teamwork is definitely the development of team spirit. Teamwork is actually like a reflection of a collective spirit to work to act collectively; togetherness reveals the team spirit created. This team spirit is one of the key points that will enable you to do successful work. Another benefit of effective teamwork is that it increases work motivation.



## New generation meeting room

Now, thanks to technology, we can easily run more than one job, even though we cannot be physical, we can be where we want to be visual. One of the simplest ways to provide this communication is through video conferences. we thought of you, thanks to the screen module BUSYPODs contains, it will be a new convenience for both your video conferences and team meetings. In addition, thanks to its sound insulation and acoustic structure, it will provide you with extra comfort.



Busy Light



Power Module



Ergonomic Table



Air Ventilation



Coat Hanger



Stainless Footstep



Acoustic Felt Panel

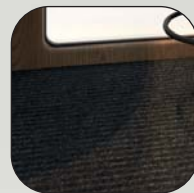

Carpet



LED Lighting

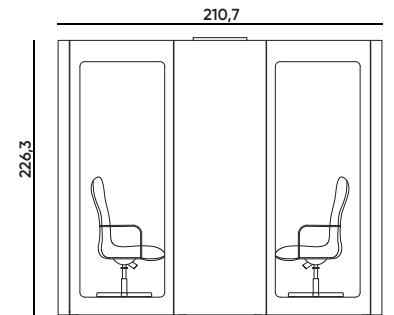
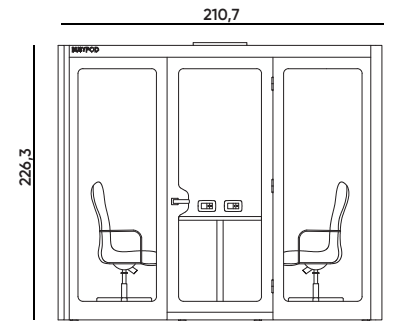
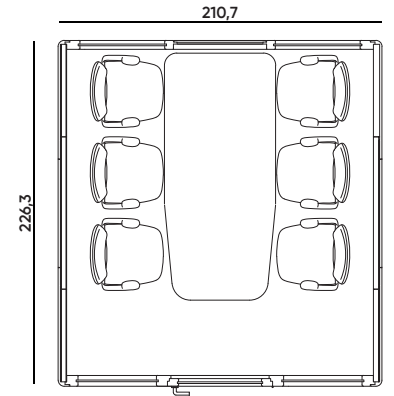

**BUSYPOD XLarge** is the ideal booth for your meetings, whether present or online. It provides you with an optimum space that allows everyone to move freely by gathering your team of six to eight people around a large table where everyone can fit comfortably. You can arrange your meetings with a screen placed on the back wall to ensure that everyone present, physically or virtually, shares their own ideas



## Exterior Side Panel



Black (RAL 9005)



White (RAL 9016)



Grey (RAL 7042)



Dark Grey (RAL 7016)



Yellow (RAL 1021)



Red (RAL 3002)



Blue (RAL 5012)



Green (RAL 6019)

Optional Unlimited Colors



## Window / Door Frame & Table Materials



Oak



Pine



Walnut

## Optional

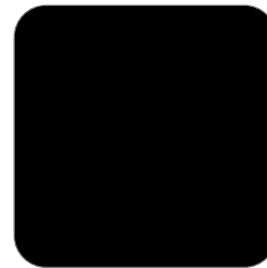

Black Lacquer

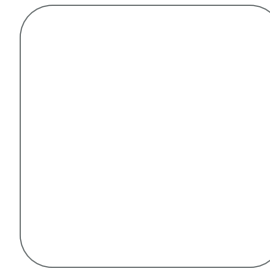

White Lacquer

Unlimited Colors



## Standart



Grey

## Optional



Dark Grey



Green

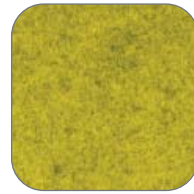

Yellow



Blue

## Felt Materials

## Upholstery Materials



Charcoal (EGL37)



Grey Brindle (EGL50)



Galvanise (EGL26)



Spark (EGL10)



Copper (EGL14)



Tungsten (EGL07)



Olive (EGL31)



Alloy (EGL05)



Burnish (EGL11)



Ferrous (EGL15)



Vitreous (EGL01)



Hemlock (EGL34)



Chromoly (EGL19)



Verdigris (EGL21)



Quench (EGL23)



Prime (EGL16)



Solder (EGL18)



Tensile (EGL20)



Hammer (EGL27)



Deep Sea (EGL48)



Lagoon (EGL35)



Crucible (EGL24)



Fuse (EGL08)



Woodrose (EGL33)



Resin (EGL04)



Wire (EGL03)



Cast (EGL25)



Abrid (EGL13)



Molten (EGL09)



Forge (EGL12)



Deep Clay (EGL32)



Otter (EGL36)



Twig (EGL49)

**Camira-Rivet** is our standard fabric option (Before decision, please ask availability in stock for quicker delivery). We have many other fabric options (which may apply extra costs). You can click on the name of the fabrics to see. **Camira-Phoenix, Camira-Citadel, Camira-Rivet, Camira-Xtreme, Camira-X2, Camira-Advantage, Camira-Era, Camira-Gravity, Camira-Blazer, Camira-Manila, Camira-Synergy, Spradling-Silververtex, Spradling-Valencia, Camira-Silk, Camira-Main Line Flax, Kvadrat-Remix 3**



Supports socket types of all countries



Fire Sprinkler and Warning System



Screen by product size



Coat Hanger



Wireless Charger

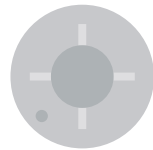

Motion Sensor



Data Line



Door Lock



Remote



Ramp for Disabled Access



Felt Side Panel



Casters (Wheels)



**BUSYLOUNGE (4)**

Stand out with your bright ideas

Although BUSYLOUNGE is called a new generation workspace, it is a mobile office section that you can set up with 2 people without making any changes, and where you can come together and work with your colleagues. Thanks to its portability feature after installation, you can move it to the appropriate place you want and hold your meetings there. BUSYLOUNGE, which is plain and very aesthetic, has been designed to adapt to different office environments with every detail in mind.



Casters (Wheels)



Power Module



Ergonomic Table



Adjustable Stool



LED Lighting



Stainless Footstep



Table Feet

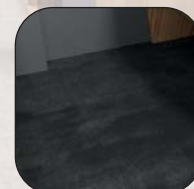

Carpet

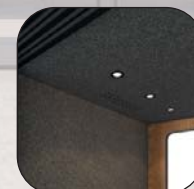

LED Lighting

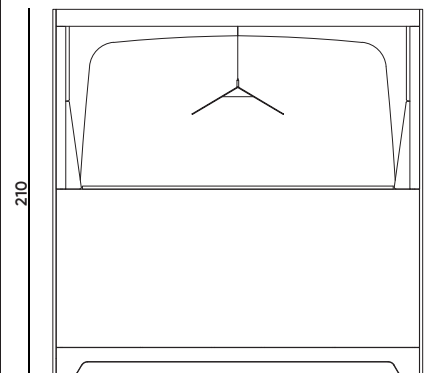
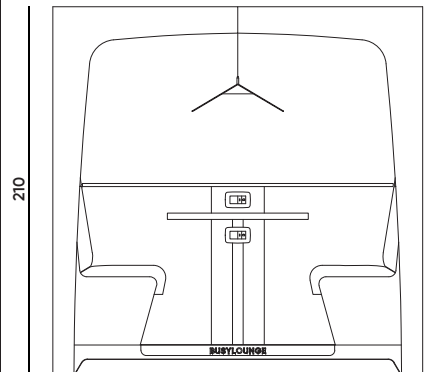
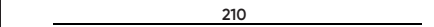
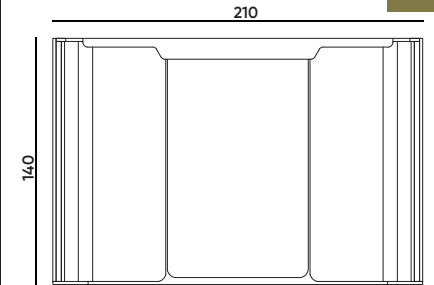





## BUSYLOUNGE 4

Creates the potential for social interaction, strong networking and collaborative workspaces, creativity, unexpected pleasant coincidences, innovative and advanced business models between your busy work.

You will love your workspace more than before.

You will feel happy in BUSYLOUNGE and you will be able to focus on your work much faster and achieve visible results. It will make you very happy to have fun while working in this wonderful product, which isolates yourself from the complexity around you and has a simple structure. Thanks to the hidden wheels on the floor, you can move it to the area you want in your office and turn it in the direction you want.



Casters (Wheels)



Power Module



Ergonomic Table



Adjustable Stool



LED Lighting



Stainless Footstep



Table Feet

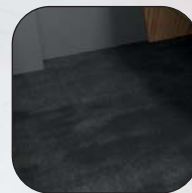

Carpet

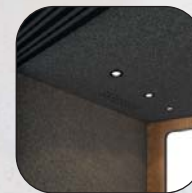

LED Lighting

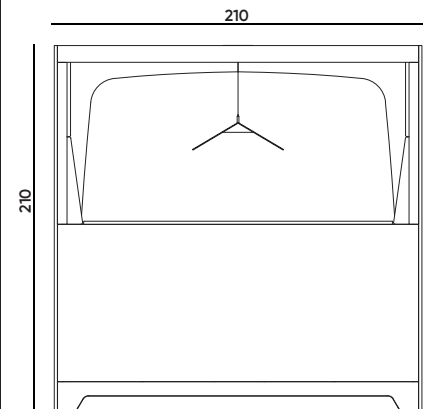
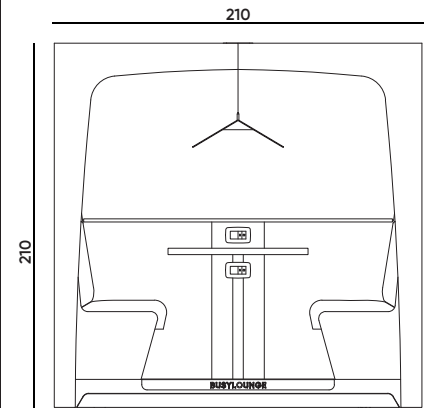
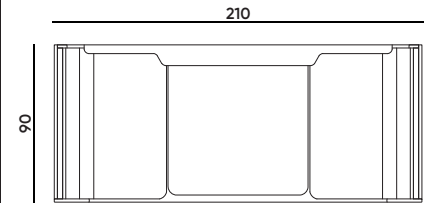

## BUSYLOUNGE 2

Provides you a space where you can work productively and spend a pleasant time with your friends in the office environment.

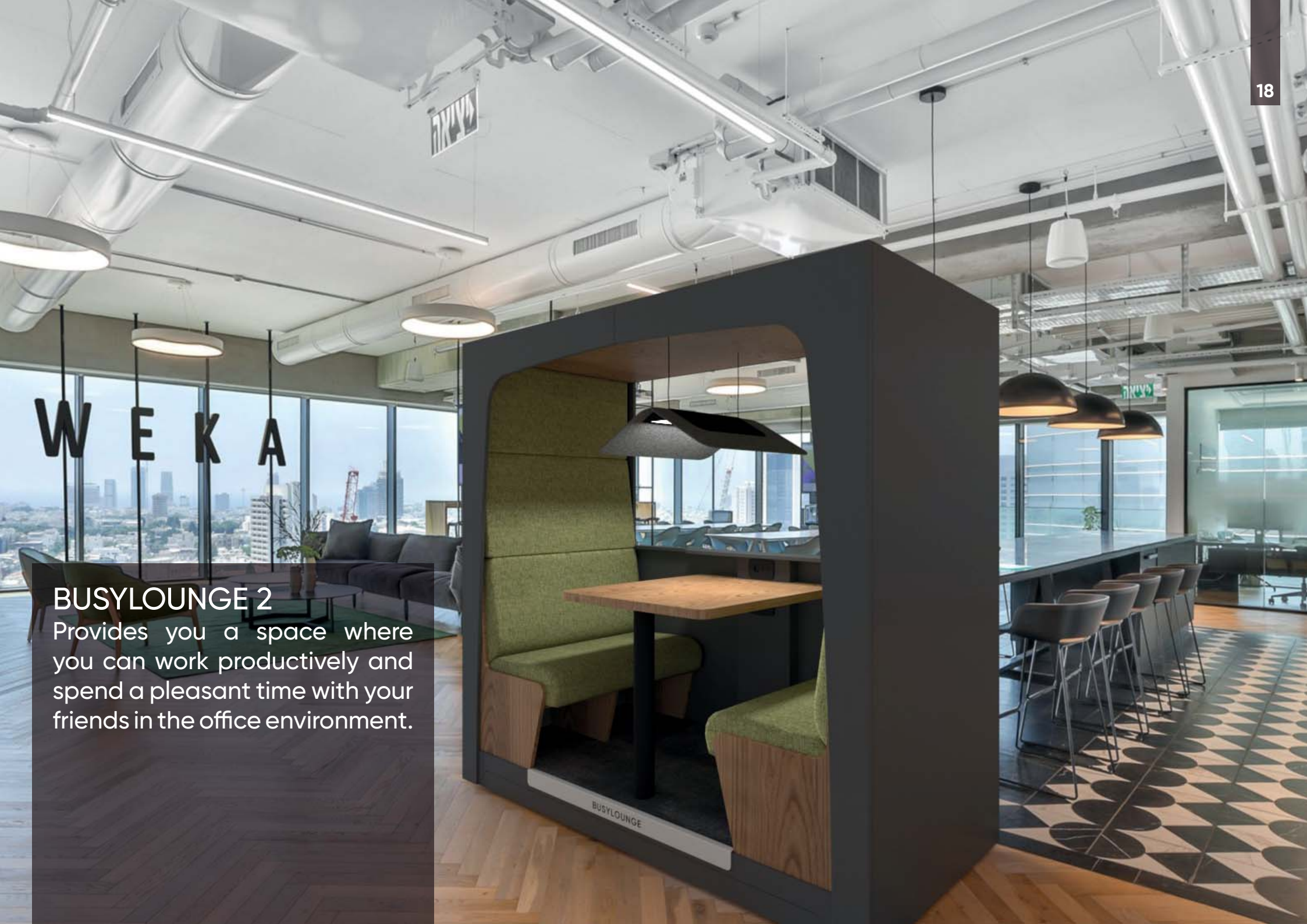

# BUSYPOD

Design Of Silence

## Production & Logistics Facility

Ataşehir Ferhat Paşa Mah. Mareşal  
Fevzi Çakmak Cd. 23. Sok. No:16  
34888 Ataşehir / İstanbul / Turkey

## Contact

+90 216 505 50 02  
info@busypod.com  
www.busypod.com

## Main Office

Kisikli Mahallesi  
Alim Street No:1/A  
34692 - Uskudar / İstanbul / Turkey



instagram/busypod



Linkedin/busypod

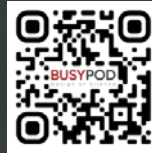

www.busypod.com



Apple Store Application



Google Play Application