

aba





moduli e dimensioni • modules and dimensions •
 modules et dimensions • Module und Abmessungen •
 modules en afmetingen • módulos y dimensiones



d: 46 cm
d: 18"

d: 36 cm
d: 14"

* w: 80 cm, NO d:36 cm
 * w: 31 1/2", NO d:14"

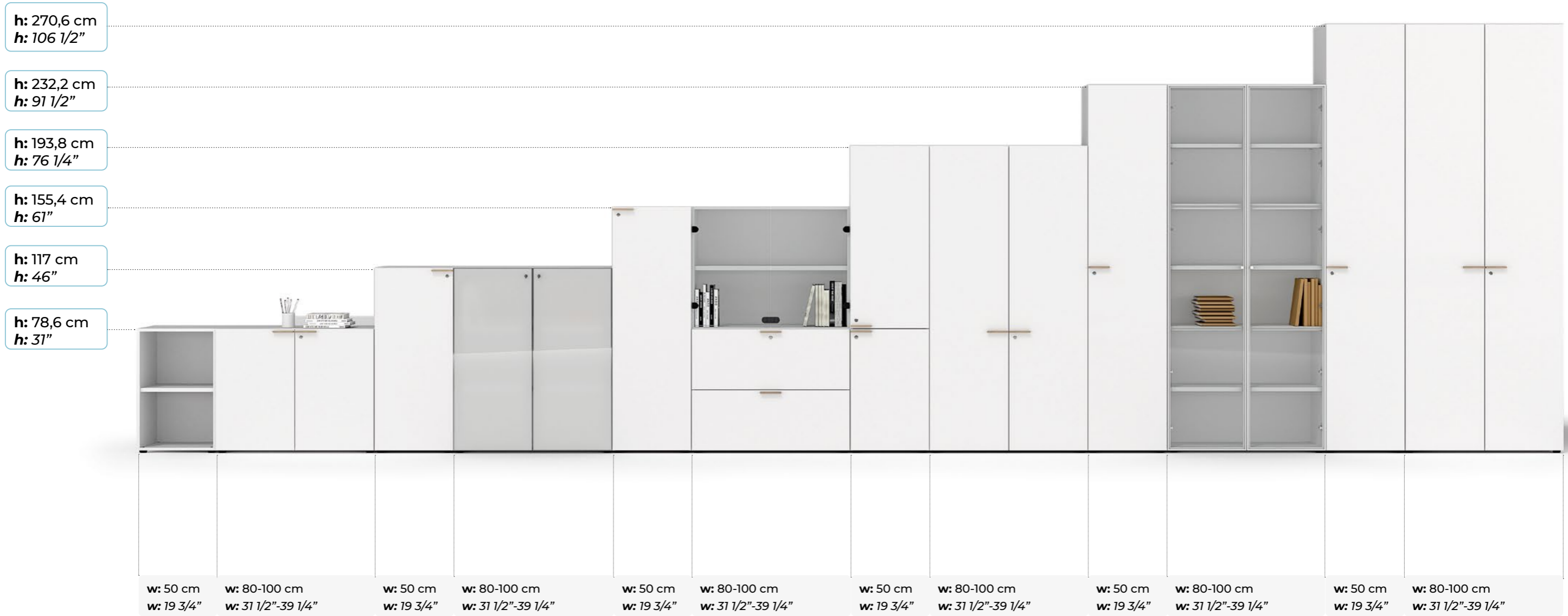
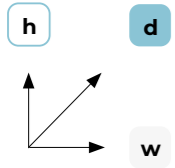

accessori • accessories • accessoires •
Zubehör • accessoires • accesorios



riploga appendiabili
pull-out coat hanger
portemanteaux extractible
Ausziehbare Kleiderstange
kleerhangerrail
percha extraible



barra di rinforzo per ripiano fisso e mobile in melaminico
reinforced bar for fixed and movable melamine shelf
barre de renforcement pour étagère en mélamine fixe et mobile
Verstärkung für feste und mobile Fachboden aus Melamin
verstevigingsbalk voor vast en mobiele melamine schap
barra de refuerzo para estante fijo y móvil de melamina

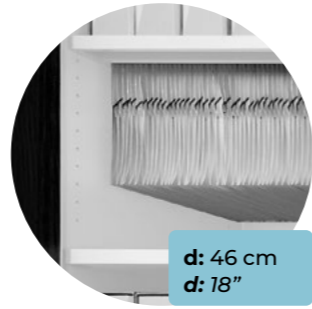

d: 46 cm
d: 18"

ripiano metallico porta cartelle
metallic shelf file holders
étagère en métal porte DS
Metallboden mit Mappenaufhängung
metalen schap voor mappen
estante metalico para carpetas



d: 46 cm
d: 18"

fondo per telaio estraibile
bottom for files frame
fond pour cadre extractible
Bodenplatte für Hängeauszug
bodem voor uitneembaar frame
fondo para extraible

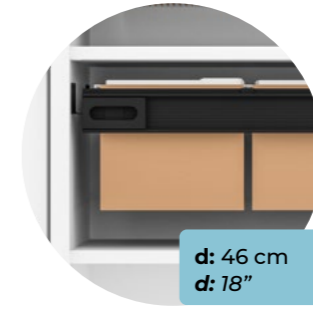

d: 46 cm
d: 18"

telaio estraibile porta cartelle (consultare il listino)
pull-out frame for folders (see price list)
porte-dossiers extractibles (voir la liste des prix)
Hängeauszug Rahmen für Ordner (siehe Preisliste)
uitneembaar frame voor mappen (zie prijslijst)
soporte extraible para carpetas (ver lista de precios)



barra porta cartelle su ripiano melaminico
metal Files bar for melamine shelf
barre porte DS pour étagère en mélamine
Mappen-Aufhängeschiene auf Melaminboden
balk voor mappen op een melamine schap
barra para carpetas bajo estante en melamina

h: 270,6 cm
h: 106 1/2"

h: 232,2 cm
h: 91 1/2"

h: 193,8 cm
h: 76 1/4"

h: 155,4 cm
h: 61"

h: 117 cm
h: 46"

h: 78,6 cm
h: 31"

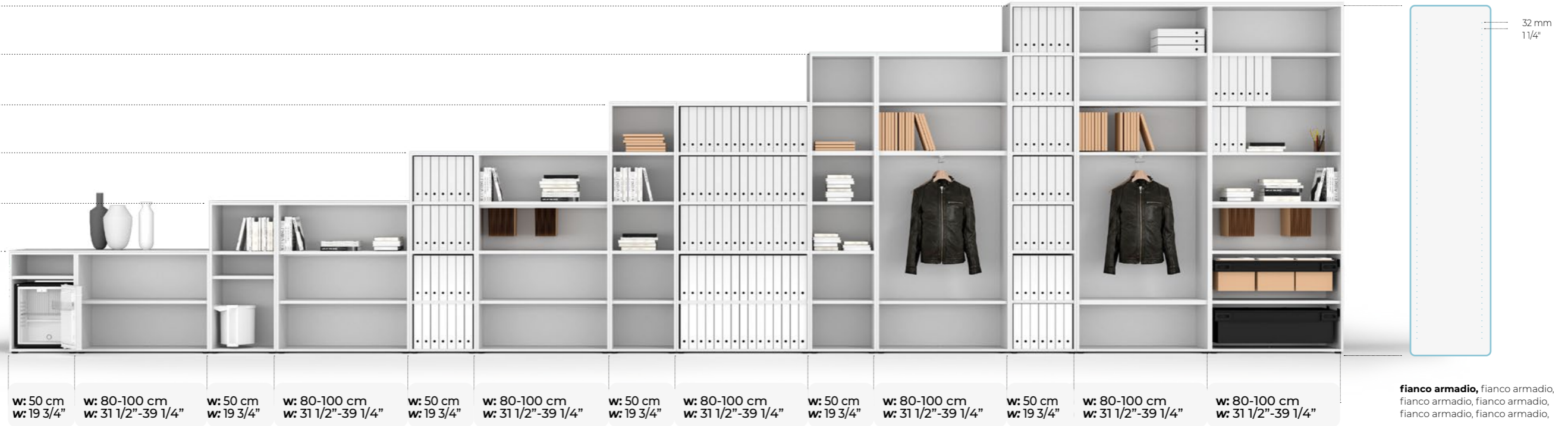

w: 50 cm
w: 19 3/4"

w: 80-100 cm
w: 31 1/2"-39 1/4"

w: 50 cm
w: 19 3/4"

w: 80-100 cm
w: 31 1/2"-39 1/4"

w: 50 cm
w: 19 3/4"

w: 80-100 cm
w: 31 1/2"-39 1/4"

w: 50 cm
w: 19 3/4"

w: 80-100 cm
w: 31 1/2"-39 1/4"

w: 50 cm
w: 19 3/4"

w: 80-100 cm
w: 31 1/2"-39 1/4"

w: 50 cm
w: 19 3/4"

w: 80-100 cm
w: 31 1/2"-39 1/4"

w: 80-100 cm
w: 31 1/2"-39 1/4"

32 mm
1 1/4"

fianco armadio, fianco armadio,
fianco armadio, fianco armadio,
fianco armadio, fianco armadio,



d: 46 cm
d: 18"

w: 50 cm
w: 19 3/4"

frigorifero da incasso - 30 l
built-in refrigerator - 30 l
réfrigérateur encastrable - 30 l
Eingebauter Kühlschrank - 30 l
ingebouwde koelkast - 30 l
nevera empotrable - 30 l



porta rifiuti
trashcan
corbeille à papier
Papierkorb
afvalmand
papelera



schiena di finitura (18 mm, 0 3/4")
finishing back panel (18 mm, 0 3/4")
dos de finition (18 mm, 0 3/4")
Sichrückwand (18 mm, 0 3/4")
afwerking achterkant (18 mm, 0 3/4")
trasera de acabado (18 mm, 0 3/4")



cerniera 170° (no ante vetro)
170° opening hinges (not for glass doors)
ouverture charnières 170° (pas pour portes vitrées)
Scharnier mit 170°-Öffnung (nicht für Glastüren)
scharnier 170° (zonder glazen deuren)
apertura bisagras 170° (no para puertas de vidrio)



kit slow-motion per cerniera 110° (no per ante legno)
slow-motion kit for 110° hinge (no for wooden doors)
kit slow-motion pour charnière 110° (pas pour portes en bois)
Anschlagdämpfer für Scharnier mit 110°-Öffnung (nicht für Holztüren)
slow-motion per scharnier 110° (niet voor hout deuren)
slow-motion para bisagra 110° (no para puerta en madera)

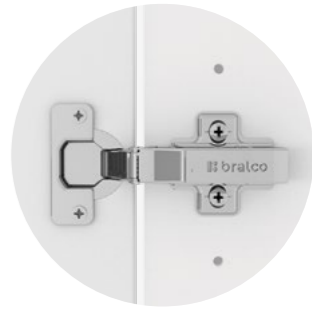

cerniera 110° slow-motion per ante legno
110° slow-motion hinge for wooden doors
Charnière slow-motion 110° pour portes en bois
110° Zeitlupenband für Holztüren
110° slow-motion scharnier voor houten deuren
bisagra 110° slow-motion para puerta en madera

ABA lockers

h: 193,8 cm
h: 76 1/4"

h: 155,4 cm
h: 61"

h: 117 cm
h: 46"

h: 78,6 cm
h: 31"

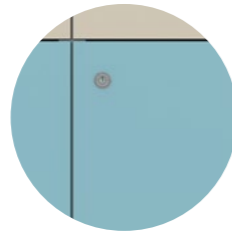
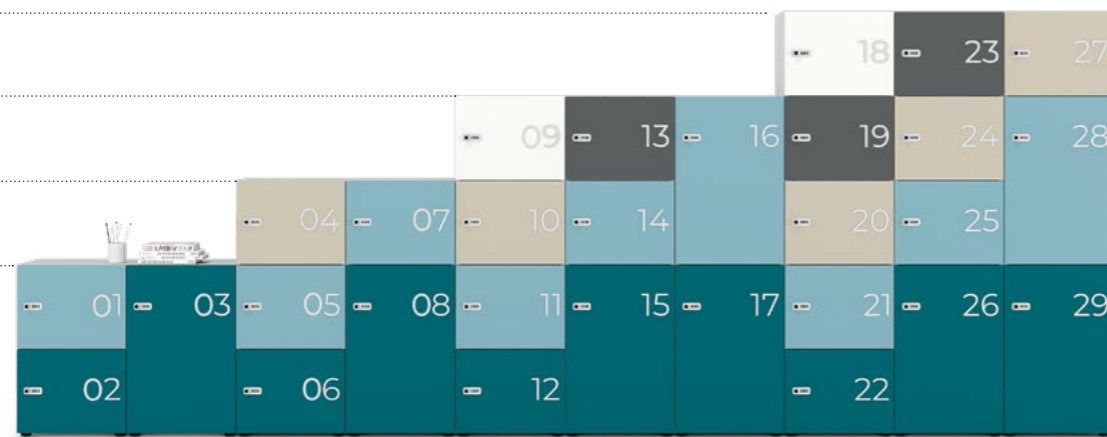

chiusura con serratura
key locking system
fermeture avec serrure
Schließung mit Schloss
sluiting met slot
cerrada con cerradura

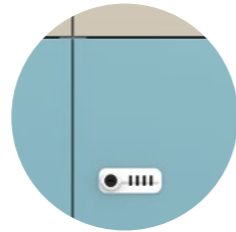

chiusura con combinazione
combination locking system
fermeture avec combinaison
Schließung mit Kombination
sluiting met combinatie
cerradura con combinacion

massima fruibilità • maximum usability • facilité d'utilisation •
maximale Ausnutzung • maximale bruikbaarheid • maxima facilidad de uso

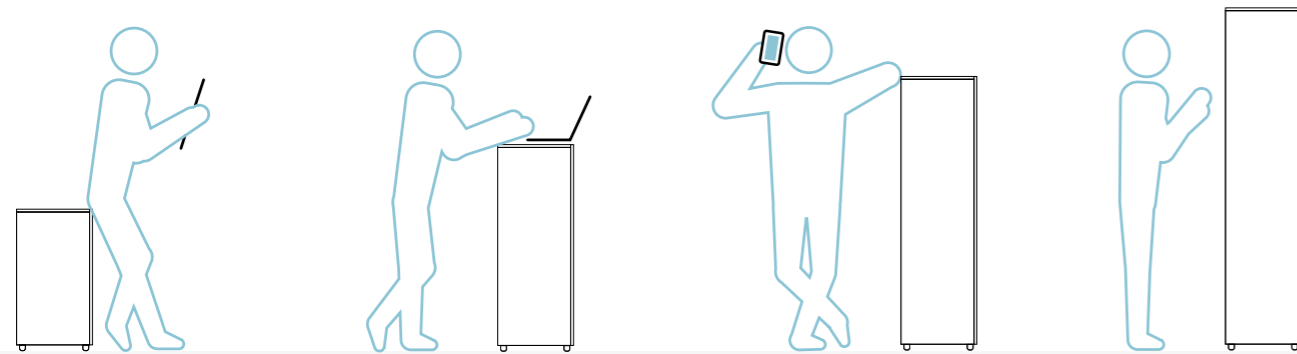

componenti e finiture • components and finishes •
composants et finitions • Bauteile und Oberflächen •
componenten en afwerkingen • componentes y acabados

top e fianchi di finitura, top and sides, top et flanc de finition,
Abdeckplatte + Seitenverkleidungen, boven en zijpanelen,
tapa-costado de cierre en madera

legno, wood, bois,
Holzfurnier, hout, madera

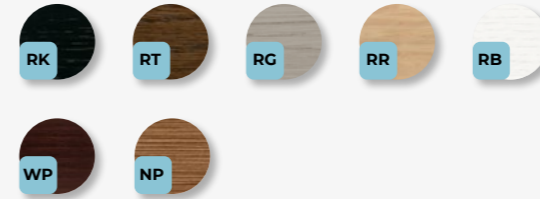

melaminico, melamine (laminated), mélamine,
melamin, melamine, melamina



laccato opaco, matt lacquered, lacqué mat,
matt lackiert, mat gelakt, laqueado mate



socca e ripiani, structure and shelves, structure et étagères,
Korpus und Einlegeböden, omhulsel en schappen, estructura
y estantes

melaminico, melamine (laminated), mélamine,
melamin, melamine, melamina



metallo (solo ripiani D:46, D:18), metal (only for shelves d:46cm,
d:18"), métal (seulement pour étagères p:46cm, p:18"), Metall (nur
für Regale T:46cm, T:18"), metaal (alleen voor schappen d:46cm,
d:18"), metal (solo para estantes p:46cm, p:18")

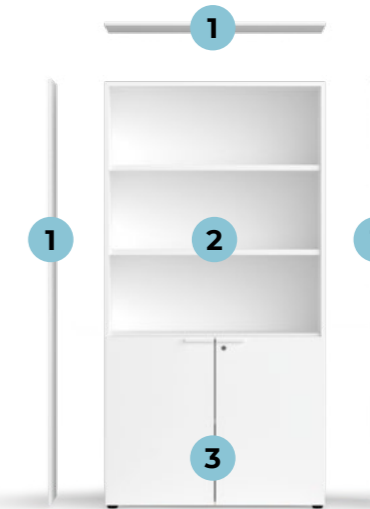

top: obbligatorio fino ad H.155,4 cm - 61"
top: compulsory up to h.155,4cm - 61"
top: obligatoire jusqu'à h.155,4cm - 61"
Abdeckplatte: obligatorisch bis zur Höhe 155,4 cm - 61"
bovenpaneel: verplicht tot h.155,4cm - 61"
tapa:obligatoria hasta h.155,4cm - 61"



top-fianco in melaminico o laccato
melamine (Laminated) or lacquered top-closing side
top-flanc de finition en mélamine ou laqué mat
Abdeckplatte+Seitenverkleidungen aus Melamin od.matt lackiert
bovenpaneel-zijpaneel in melamine of gelakt
tapa-costado de cierre en melamina o laqueado mate

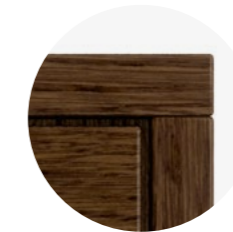

top-fianco in legno
wood top-closing side
top-flanc de finition en bois
Abdeckplatte+Seitenverkleidungen furniert
bovenpaneel-zijpaneel in hout
tapa-costado de cierre en madera

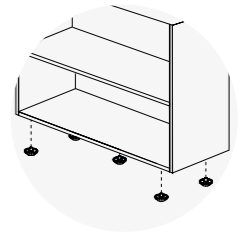

5° piedino antiflessione standard
no-bending standard 5th foot
5° vérin anti-flexion standard
Standard Fünfter Verstärkungsfuss
5de anti-flex poot standaard
5° pie que no flexiona estándar

ante senza telaio • doors without frame • portes sans châssis
Türen ohne Rahmen • deuren zonder frame • puertas sin bastidor

legno, wood, bois,
Holz furnier, hout, madera

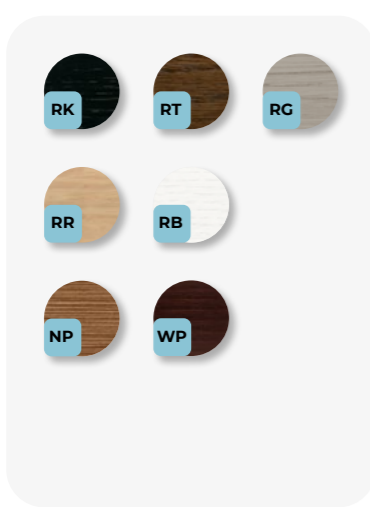

melaminico, melamine (laminated), mélamine,
melamin, melamine, melamina



laccato opaco, matt lacquered, lacqué mat,
matt lackiert, mat gelakt, laqueado mate

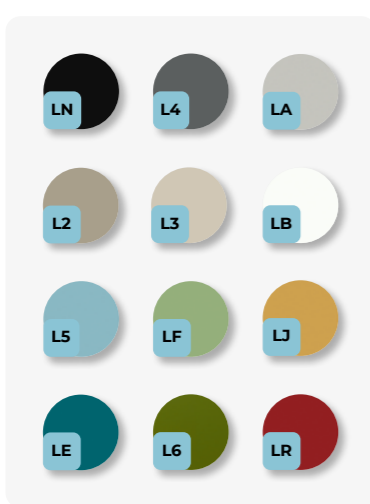

maniglie, handles, poignées,
Griffe, handgrepen, tiradores



vetro senza telaio, glass door without frame, porte en verre sans châssis,
Rahmenlose Glastür, glazen deur zonder frame, puerta de vidrio sin bastidor

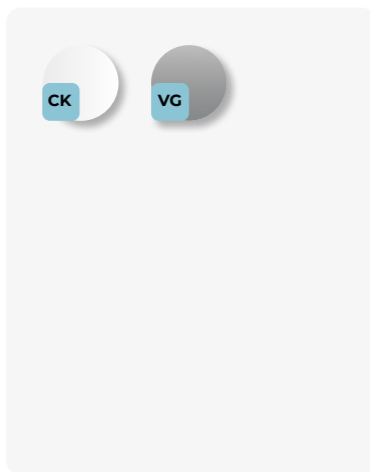

serratura per ante vetro
lock for glass door
serrure pour porte en verre
Schloss für Glastür
slot voor glazen deur
cerradura puerta de vidrio

ante con telaio • doors with frame • portes avec châssis
Türen mit Rahmen • deuren met frame • puertas con bastidor

vetro con telaio base, glass door with standard frame, porte en verre avec châssis base,
Glastür mit Standardrahmen, basisframe glazen deur, puerta de vidrio con bastidor base

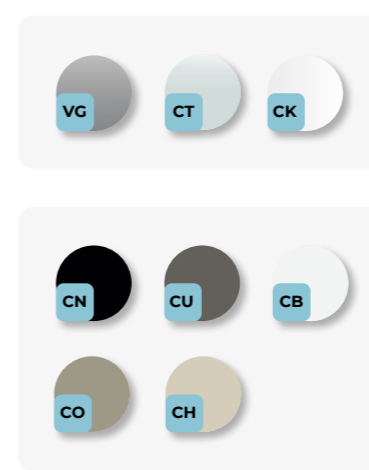

finiture telaio, frame finish, finitions
châssis, Rahmenoberflächen,
afwerking frame, acabados bastidor

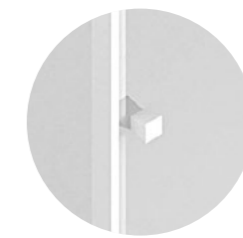
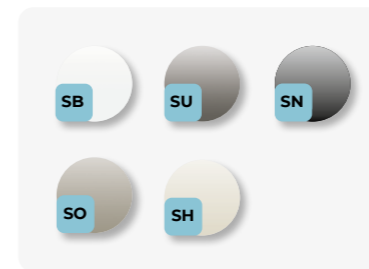
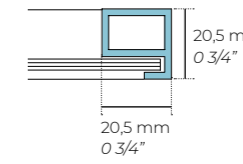

pomolo ante vetro
knob for glass door
pommeau pour porte en verre
Griff für Glastür
knop voor glazen deur
tirador puerta de vidrio

vetro con telaio cromato, glass door with chromed frame, porte en verre avec châssis chromé,
Glastür mit Chromrahmen, glazen deur met verchromd frame, puerta de vidrio con marco cromado

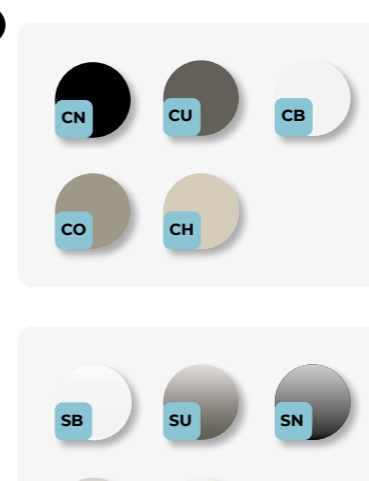

finiture telaio, frame finish, finitions
châssis, Rahmenoberflächen,
afwerking frame, acabados bastidor

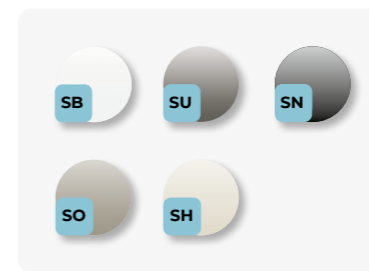
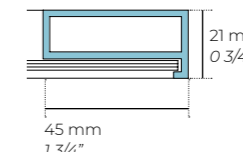
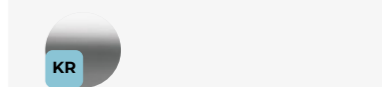

pomolo ante vetro
knob for glass door
Pommeau pour porte en verre
Griff für Glastür
knop voor glazen deur
tirador puerta de vidrio

* **cerniere soft optional**, optional soft-closing hinge, charnière
avec fermeture ralentie en option, Optionale Scharniere mit
Anschlagsdämpfer, optionele scharnieren soft, bisagra soft opcional

* **cerniera soft di serie**, standard soft-closing hinge, charnière
avec fermeture ralentie de série, Serienmäßige Scharniere mit
Anschlagsdämpfer, standaard scharnieren soft, bisagra soft de serie

numerosa combinazioni di finiture • numerous finishes combinations •
 nombreuses combinaisons de finitions • Zahlreiche Kombinationen von Oberflächen •
 talrijke combinaties van afwerkingen • muchas combinaciones de acabados

numero finiture, number of finishes, numéro de finitions,
 Anzahl Oberflächen, aantal afwerkingen, numero de acabados

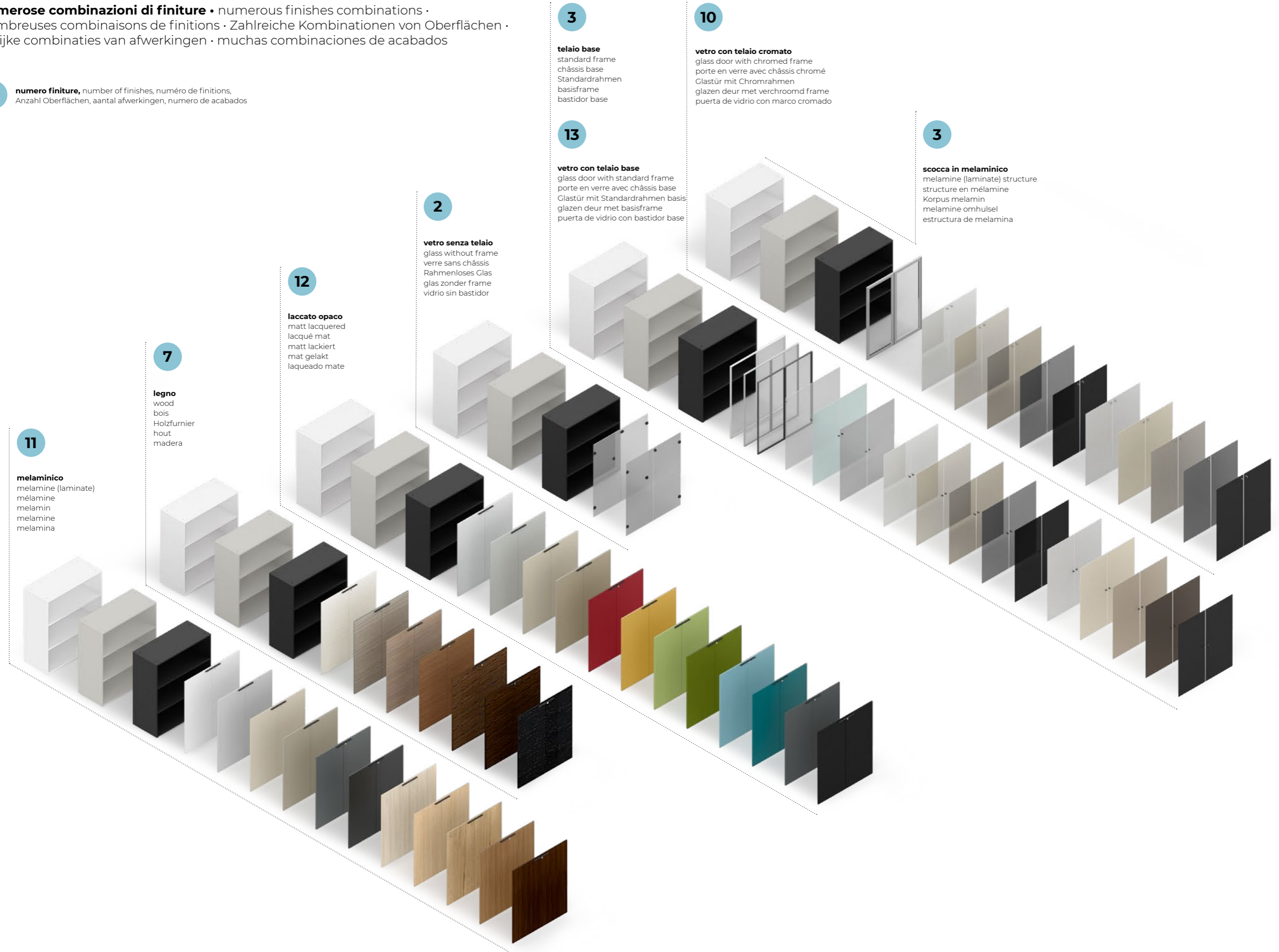

11

melaminico
 melamine (laminated)
 mélamine
 melamin
 melamine
 melamina

7

legno
 wood
 bois
 Holzfurnier
 hout
 maderá

12

laccato opaco
 matt lacquered
 lacqué mat
 matt lackiert
 mat gelakt
 laqueado mate

2

vetro senza telaio
 glass without frame
 verre sans châssis
 Rahmenloses Glas
 glas zonder frame
 vidrio sin bastidor

13

vetro con telaio base
 glass door with standard frame
 porte en verre avec châssis base
 Glasür mit Standardrahmen basis
 glazen deur met basisframe
 puerta de vidrio con bastidor base

3

telaio base
 standard frame
 châssis base
 Standardrahmen
 basisframe
 bastidor base

10

vetro con telaio cromato
 glass door with chromed frame
 porte en verre avec châssis chromé
 Glasür mit Chromrahmen
 glazen deur met verchromd frame
 puerta de vidrio con marco cromado

3

scocca in melaminico
 melamine (laminated) structure
 structure en mélamine
 Korpus melamin
 melamine omhulsel
 estructura de melamina



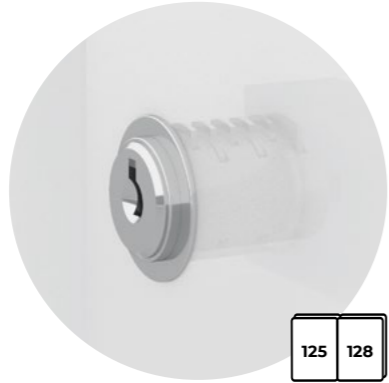

serratura con nottolino estraibile
lock with removable cam
serrure avec barillet extractible
Abnehmbarer Schlosszylinder
slot met uitneembare pal
cerradura con trinchete extraíble

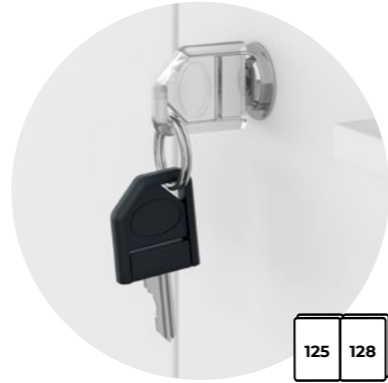

coppia chiavi pieghevoli
pair of foldable keys
paire de clés pliantes
Paar faltbare Schlüssel
paar vouwbare sleutels
par de llaves plegables



anta con parapolvere montato
door with duster
porte avec cache-poussière intégré
Tür mit Abdichtleiste
deur met gemonteerde stofkap
puerta con goma para bloquear el polvo

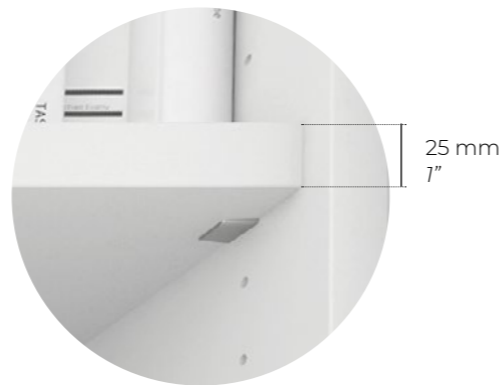

ripiano con reggiripiano
shelf with support
étagère avec support
Fachboden mit Halterungen
schap met schappensteun
estante con soportes

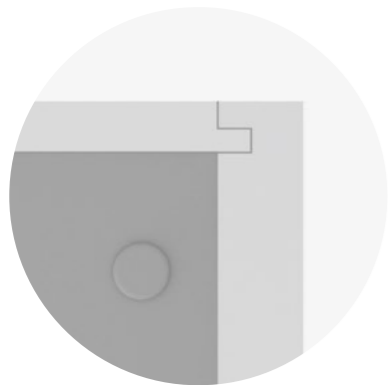

schiena strutturale da 10 mm, 0 1/4"
structural back panel 10 mm, 0 1/4" thick
dos structurel ép. 10 mm, 0 1/4"
10 mm, 0 1/4" starke Rückwand
structurele achterkant van 10 mm, 0 1/4"
traserá estructural de 10 mm, 0 1/4"

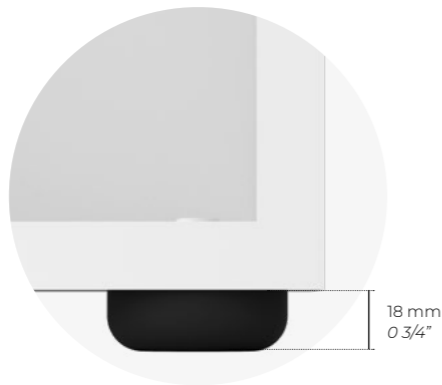

pedino livellatore
levelling foot
vérin de compensation
Niveausgleichsfuss
stelpoot
pie nivelador

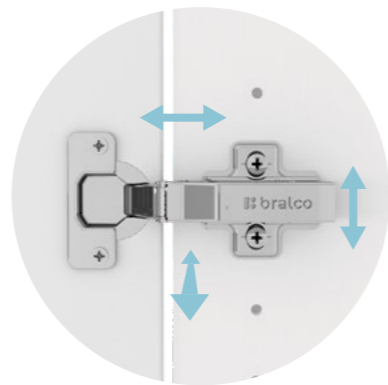

anta con cerniera regolabile montata
door with levelling hinge
porte avec charnière réglable montée
Tür mit montiertem einstellbarem Scharnier
deur met gemonteerde, verstelbaar scharnier
puerta con bisagra regulable montada

forms

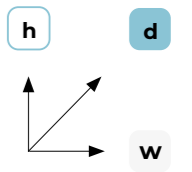

d: 36-46 cm
d: 14" - 18"

w: 50 cm,
w: 19 3/4"

w: 80 - 100 cm
w: 31 1/2" - 39 1/4"

h: 78,6 cm
h: 31"

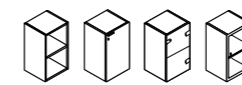

Lockers

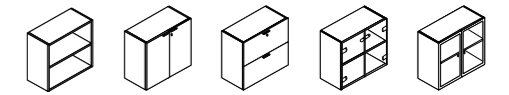
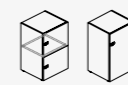

h: 117 cm
h: 46"

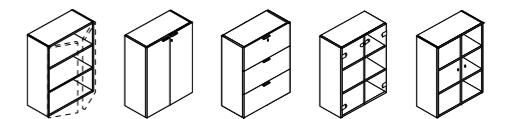
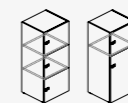
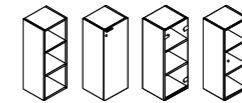

h: 155,4 cm
h: 61"

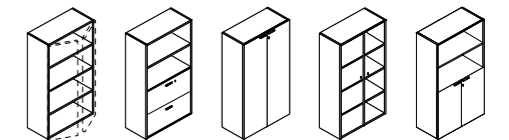
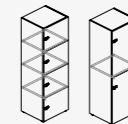
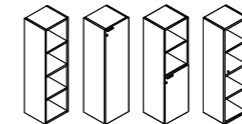

h: 193,8 cm
h: 76 1/4"

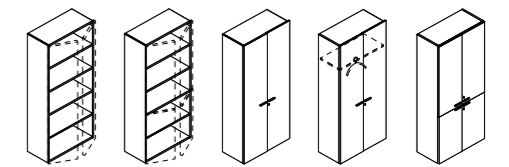
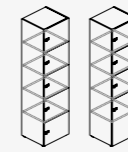
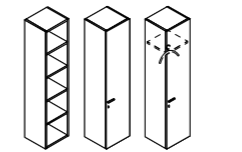

h: 76,8 cm
h: 30 1/4"

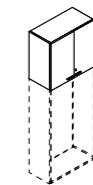

h: 232,2 cm
h: 91 1/2"

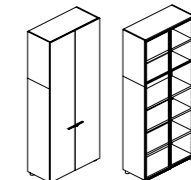
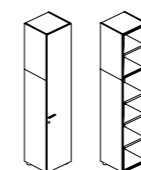

w: 80 cm - NO d: 36 cm
w: 31 1/2" - NO d: 14"
*NO d: 36 cm
*NO d: 14"

coppia fianchi di chiusura, pair of fastening sides, paire flancs de finition,
Paar Seitenverkleidungen, paar afsluitende zijpanelen, par de costados de cierre

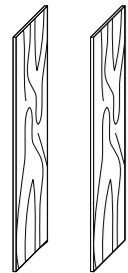

a - melaminico/ laccato opaco, melamine (Laminate)/matt lacquered,
mélamine/laqué mat, Melamin/matt lackiert, melamine/mat gelakt
melamina/laqueado mate

b - legno, wood, bois,
Holzfurnier, hout, maderá

	w	h	d
a.	1,2 cm, 0 1/2"	78,1÷270,1 cm 30 3/4"÷106 1/4"	36-46 cm 14"-18"
b.	1,3 cm, 0 1/2"	76,8÷192 cm 30 1/4"÷75 1/2"	46 cm 18"

top*, top*, top*, Abdeckplatte*,
bovenpaneel*, Tapa*

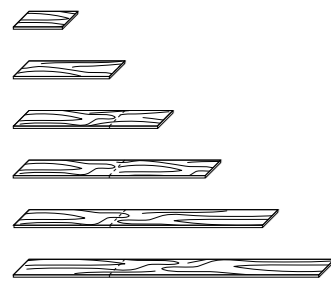

	w	h	d
a.	50÷300 cm, 19 3/4"÷118"	1,2 cm, 0 1/2"	36-46 cm 14"-18"
b.	52,7÷302,7 cm, 20 3/4"÷119"	1,3 cm, 0 1/2"	1,3 cm, 0 1/2"

***obbligatorio per armadi fino ad h 155,4 cm - 61"**

*compulsory for bookcases up to h.155,4 cm - 61"

*obligatoire pour les armoires jusqu'à h.155,4 cm - 61 "

*obligatorisch für Schränke bis zur Höhe 155,4 cm - 61"

*verplicht voor kasten tot h.155,4 cm - 61"

*obligatorio para armarios hasta h.155,4 cm - 61"

connessione top-fianco, top-side connector, connection top-flanc,
Verbindung Abdeckplatte-Seite, verbinding bovenpaneel-zijpaneel, conexion tapa-costado

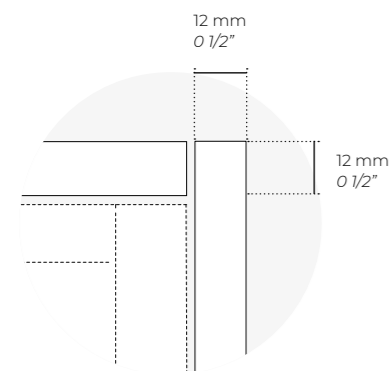

a* - dx

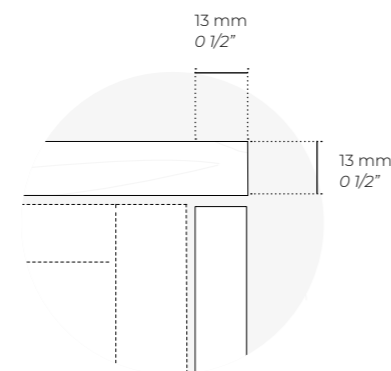

b - dx**

***in presenza del fianco: top obbligatorio**, *with side fastener: top is compulsory,
*en présence du flanc: top obligatoire, *Bei Seitenverkleidungen: Abdeckplatte obligatorisch,
*bij aanwezigheid zijpaneel: bovenpaneel verplicht, *con costados: tapa obligatoria

****in presenza del top: fianco obbligatorio**, **with top: Side fastener is compulsory,
**en présence du top: flanc obligatoire, **Bei Abdeckplatte: Seitenverkleidungen obligatorisch,
**bij aanwezigheid bovenpaneel: zijpaneel verplicht
**con tapa: costados obligatorios