

The logo for dekkko INTERIORS is centered within a white rounded square. The word "dekkko" is written in a bold, lowercase, dark grey sans-serif font. A small green inverted triangle is positioned above the letter 'k'. Below "dekkko", the word "INTERIORS" is written in a smaller, uppercase, dark grey sans-serif font with wide letter spacing. The entire logo is reflected below the white square.

dekkko
INTERIORS

INTERIORS



archiproducts'
DESIGN AWARDS

—
WINNER 2018

Top Finishes
Melamine (MFC)
thk.18 mm edge ABS 2 mm
Perfect Sense
thk.22 mm edge ABS 1 mm
Writable Laminate
thk.20 mm edge ABS 2 mm

4 or 6 resealable module
steel box for electricity
and/or multimedia system.
Available with cable management
(optional).
See p.6

Swivel castor with pedal brake
ø 100 mm.
Polyamide support with anti-trace
thermoplastic rubber tread.

Black linking device in
steel nylon covered to
join table tops.

Safety pin.

Elliptical steel pipe
leg 60x30 mm.

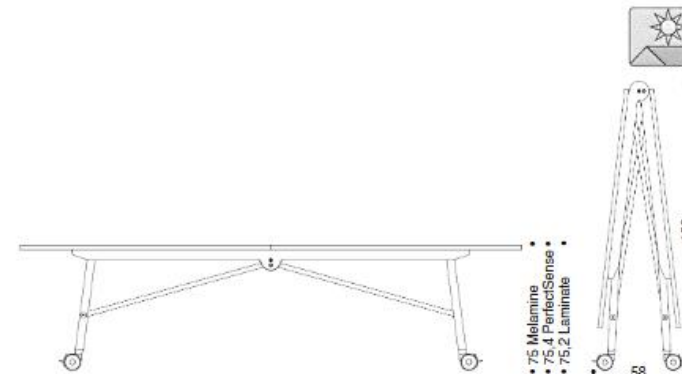

Structure Finishes



Matt powder coated.
3 Finishes available:
Blak RAL9005
Grey RAL9006
White RAL9003.

Dimension Tops in MFC *thk. 18 mm*

LENGTH cm	WIDTH cm	
	100	120
240	✓	✓
260	✓	✓
280	✓	✓
300	✓	✓
320	✓	✓

Dimension Tops lacquered in MDF in PerfectSense *thk. 22 mm*

LENGTH cm	WIDTH cm	
	100	120
240	✓	✓
260	✓	✓
280	✓	✗
300	✓	✗
320	✓	✗

Dimension Tops chipboard covered in Writable Laminate
thk. 20 mm

LENGTH cm	WIDTH cm	
	100	120
300	✓	✓

Top Finishes

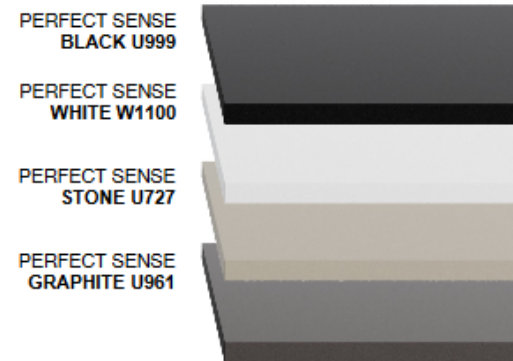

* Writable Laminate
WHITE 028

* Top only available for 300x100 and 300x120 cm.
Electrical kits not applicable for this top finish.

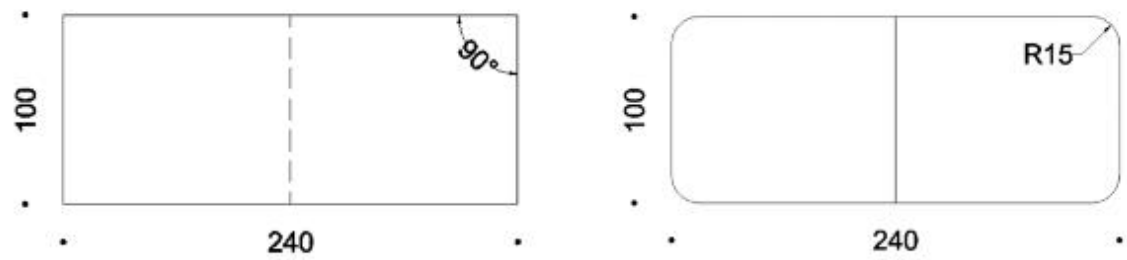

When ordering specify angles type: straight 90° or curved R15.

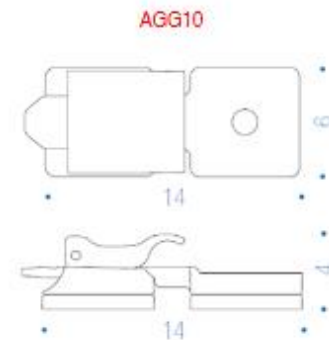

Grey linking device in nylon to join table tops available only for 90° straight angles.

Shapes and dimension tops

Top available with 90° straight angles.

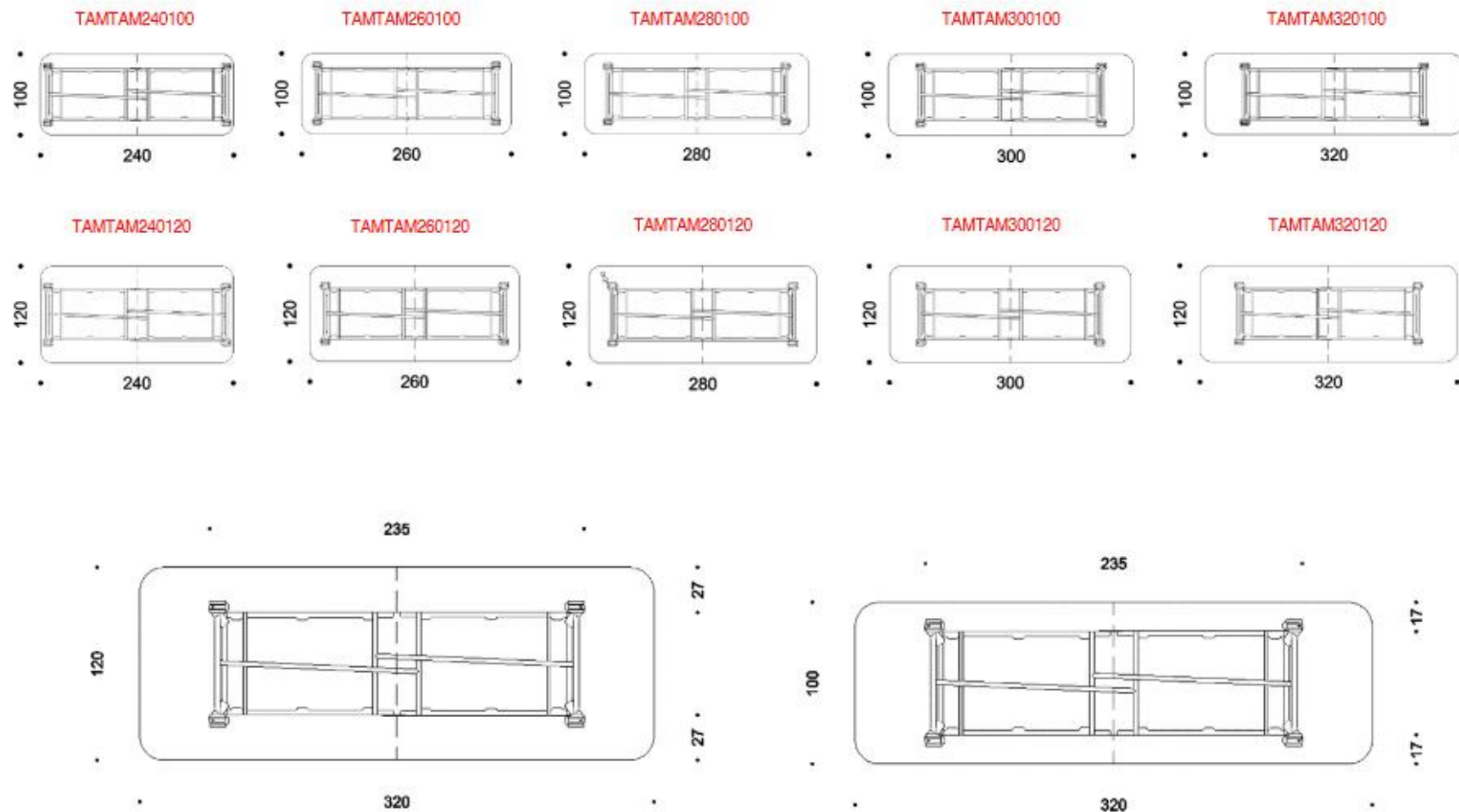

Compositions

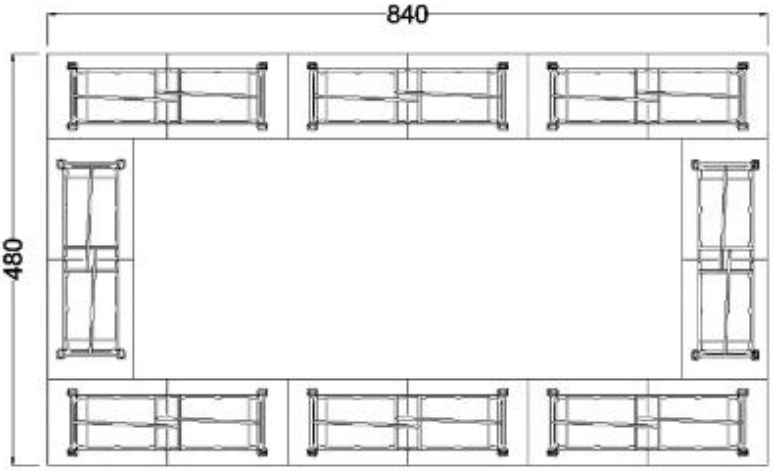
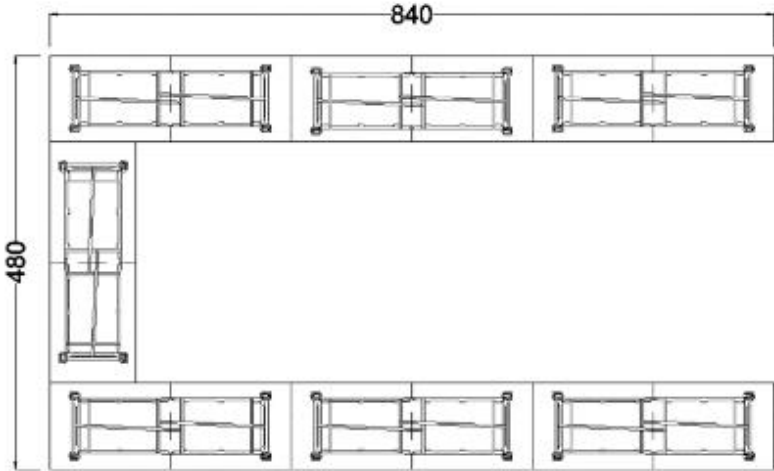



Single module in ABS for electricity and/or multimedia and system cable management.
Colors available Anthracite RAL7016 and White RAL9010.

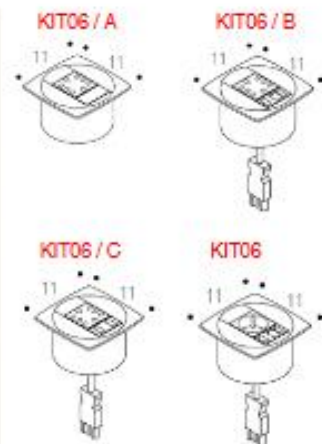

KIT03
Connection cable to joint variable plug power supply system 2 mt (H05VV-F 3G 1.5 mm² / GST18 - GST18)

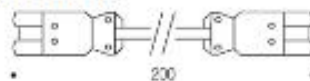

KIT09
Electric cable 2 mt (H05VV-F 3G 1.5 mm² / GST18 - Male Socket)

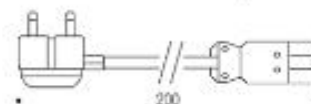

KIT12
Power distributor with 3 poles.

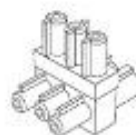

KIT13
Flexible Cable guide. Polycarbonate vertebra frame with steel base. Color Anthracite RAL 7016.



4 or 6 module steel box for electricity and/or multimedia.
Colors available Black RAL9017, Grey RAL9006 and White RAL9016.

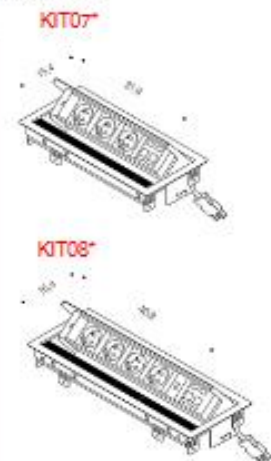

Cable management resealable module.
Colors available Black RAL9017, Grey RAL9006 and White RAL9016.



***International Sockets**



***Multimedia Accessories**



Electricity and/or multimedia position.

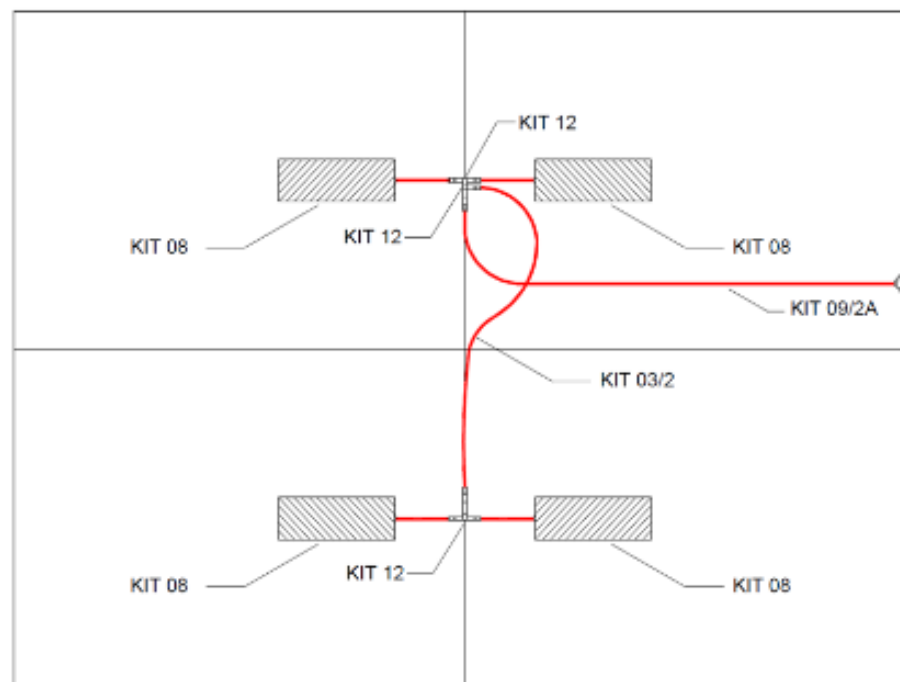
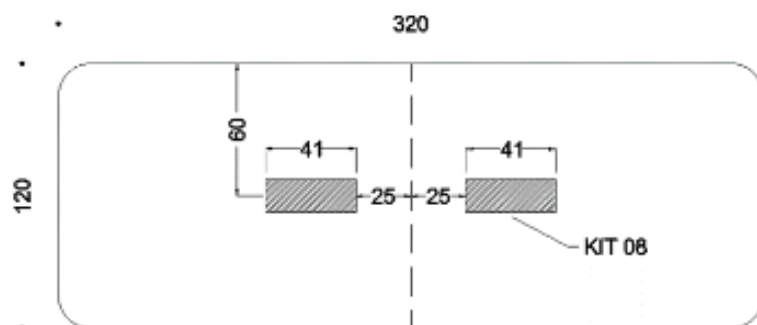
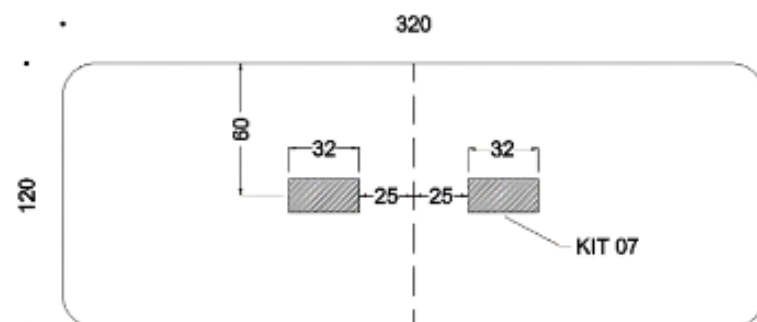
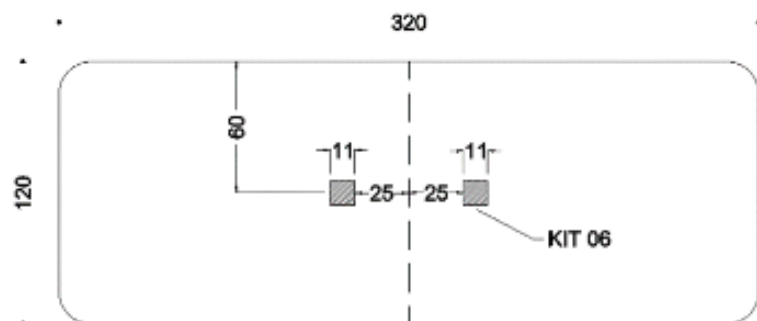

KIT 03/2 (1PZ.)

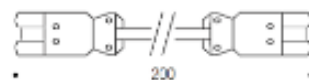

KIT 09/2A (1PZ.)

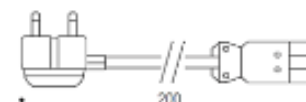

KIT 12 (3PZ.)

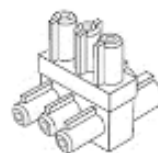

KIT 08 (4PZ.)

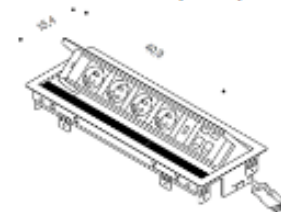

Cleaning

For the metal parts, we recommend to only use a damp cloth with alcohol and to dry all very well after cleaning.
For the MFC or lacquered MDF Perfect Sense surface top, use a damp cloth with neutral liquid detergent.
Do not use solvents, trichloroethylene, acetone or ammonia.

Guaranteed

Our products are guaranteed for 5 years.
(detailed guarantee document available upon request).



UNI EN 1730:2000

Compliance certificate with BS EN 15372:2016, level 3°.



Compliance certificate with ANSI/BIFMA X5.5-2014.