

Stor

FRIZZA[®]

2.PASSEPARTOUT

ARCHIVIAZIONE
CABINETS
SCHRÄNKE
RANGEMENTS
ARMARIOS

36.MADIA

ARMADI
CABINETS
SCHRÄNKE
RANGEMENTS
ARMARIOS

44.PEDESTALS

CASSETTIERE
PEDESTALS
ROLLCONTAINER
CAISSONS
CAJONES

MADIA

DOVE IL GIOCO DEGLI SPESSORI
DIVENTA PROTAGONISTA

WHERE THICKNESSES INTERPLAY BECOMES
THE PROTAGONIST.

WO SPIEL DER DICKE WIRD DER
PROTAGONIST.

OÙ LE JEU DE L'ÉPAISSEUR DEVIENT LE
PROTAGONISTE.

DONDE EL JUEGO DEL GROSOR SE
CONVIERTE EN PROTAGONISTA.



Madia + Pop Panel desk



cm
H 125

H. 65 L. 100

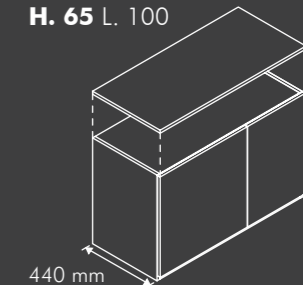

Sx
Lh

H. 65 L. 120

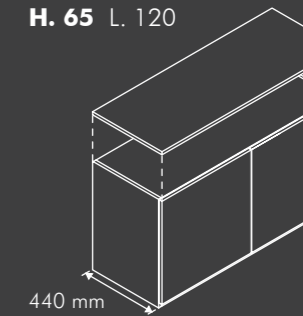

H. 125 L. 100

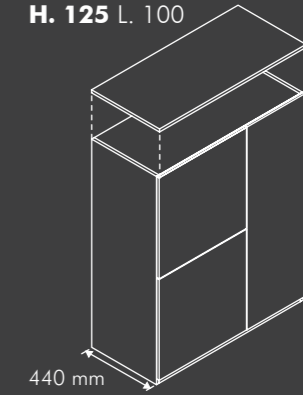

Sx
Lh

H. 125 L. 120

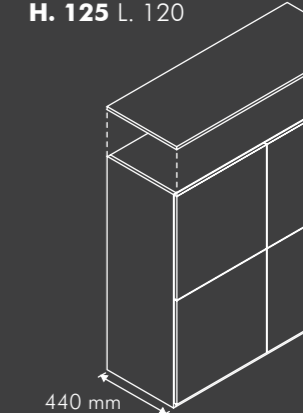

MADIA

Ante e top di finitura

Doors and top finishes _Türen und Abdeckplatten _Portes et top finitions _Acabados de puertas y sobre superior

| | | | |
|---|--|---|---|
| <p>MELAMINE DOOR</p>  <p>> 1,8 cm SPESSORE / THICKNESS</p> | <p>VENEERED DOOR</p>  <p>> 2,0 cm SPESSORE / THICKNESS</p> | <p>LAQUERED DOOR</p>  <p>> 2,0 cm SPESSORE / THICKNESS</p> | <p>GLASS DOOR</p>  <p>> 0,6 cm SPESSORE / THICKNESS</p> |
|---|--|---|---|



cm
H 125

L 100 P 44



PUSH PULL



> sp. / th. 1,8 cm
RIPIANO IN MELAMINICO
MELAMINE SHELF
MELAMINEINLEGEBODEN
ÉTAGÈRE EN MÉLAMINE
ESTANTE DE MELAMINA



> sp. / th. 0,4 cm
RIPIANO IN VETRO
GLASS SHELF
GLASBODEN
ÉTAGÈRE EN VERRE
ESTANTE DE CRISTAL



DATI TECNICI

Technical data/Technische Daten/Données techniques/Datos técnicos

H. 63 L. 100 P. 46

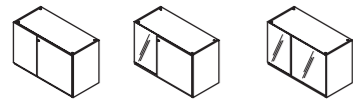

H. 123 L. 100 P. 46

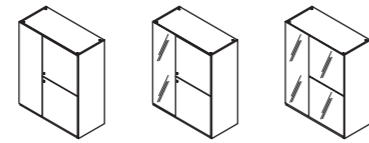

H. 63 L. 120 P. 46

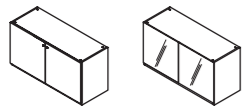

H. 123 L. 120 P. 46

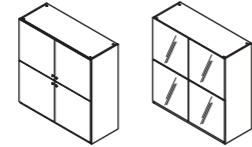

Maniglie

Handles _Griffe
Poignées _ Tirador

HOLES DISTANCE 12,8 CM



BE.1
ACMN011



VOGUE / POP / POP
ACMN002



LINK
ACMN003



MYDESK
ACMN004



TIPER / VELVET / ASSET / ALPLUS
ACMN002



ONO
ACMN014

Finishes / Ausführungen / Finitions / Acabados

scocca

STRUCTURE
KORPUS
STRUCTURE
ESTRUCTURA

melamine



MBI WHITE



MTR DOVE



MNE BLACK

finitura ante

FINISHING DOORS
OBERFLÄCHEN DER TÜREN
FINITION PORTES
ACABADO DE PUERTAS

melamine



MBI WHITE



MTR DOVE



MNE BLACK



MCE CONCRETE



MRO OAK



MNT AMERICAN WALNUT



MRC TOBACCO OAK



MOL ELM



MOB LIGHT ELM

veneer

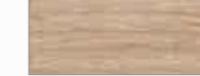

WSB BLEACHED OAK



WNJ WALNUT NEW



WOL ELM



WPA ROSEWOOD



WFN BLACK ASH

glass

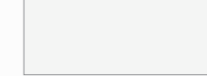

VBI WHITE PAINTED



VTR DOVE PAINTED



VNE BLACK PAINTED

lacquered



LAW1/LLW1 WHITE



LATR/LLTR DOVE



LANE/LLNE RAL 9011



LA10/LL10 RAL 1019



LARI/LLR1 RAL 3020



LAG1/LLG1 RAL 7039



LAG2/LLG2 RAL 7038



LAG3/LLG3 RAL 7012



LAG5/LLG5 RAL 7009



LAP9/LLP9
CUSTOMER COLOR

